

SECTION PCS

POWER CONTROL SYSTEM

A
B
C
D
E
F
G
H
I
J
K
L
N
O
P

CONTENTS

IPDM E/R	Diagnosis Procedure	17
FUNCTION DIAGNOSIS	POWER SUPPLY AND GROUND CIRCUIT	18
RELAY CONTROL SYSTEM	Diagnosis Procedure	18
System Diagram	ECU DIAGNOSIS	19
System Description	IPDM E/R (INTELLIGENT POWER DISTRI-	
Component Parts Location	BUTION MODULE ENGINE ROOM)	19
POWER CONTROL SYSTEM	Reference Value	19
System Diagram	Terminal Layout	20
System Description	Physical Values	20
SIGNAL BUFFER SYSTEM	Wiring Diagram	25
System Diagram	Fail Safe	30
System Description	DTC Index	32
POWER CONSUMPTION CONTROL SYS-	PRECAUTION	33
TEM	PRECAUTIONS	33
System Diagram	Precaution for Supplemental Restraint System	
System Description	(SRS) "AIR BAG" and "SEAT BELT PRE-TEN-	
Component Parts Location	SIONER"	33
DIAGNOSIS SYSTEM (IPDM E/R)	Precautions For High-Voltage System	33
Diagnosis Description	Precaution for Procedure without Cowl Top Cover...33	
CONSULT - III Function (IPDM E/R)	ON-VEHICLE REPAIR	34
COMPONENT DIAGNOSIS	IPDM E/R (INTELLIGENT POWER DISTRI-	
U1000 CAN COMM CIRCUIT	BUTION MODULE ENGINE ROOM)	34
Description	Removal and Installation	34
DTC Logic	POWER DISTRIBUTION SYSTEM	
Diagnosis Procedure	BASIC INSPECTION	35
B2098 IGNITION RELAY ON STUCK	DIAGNOSIS AND REPAIR WORKFLOW	35
Description	Work Flow	35
DTC Logic	FUNCTION DIAGNOSIS	38
Diagnosis Procedure	POWER DISTRIBUTION SYSTEM	38
B2099 IGNITION RELAY OFF STUCK	System Description	38
Description	Component Parts Location	39
DTC Logic		

PCS

Component Description	40	B261A PUSH-BUTTON IGNITION SWITCH	62
DIAGNOSIS SYSTEM (BCM)	41	Description	62
COMMON ITEM	41	DTC Logic	62
COMMON ITEM : Diagnosis Description	41	Diagnosis Procedure	62
COMMON ITEM : CONSULT-III Function	41	POWER SUPPLY AND GROUND CIRCUIT	65
INTELLIGENT KEY	41	BCM	65
INTELLIGENT KEY : CONSULT-III Function		BCM : Diagnosis Procedure	65
(BCM - INTELLIGENT KEY)	42	BCM : Special Repair Requirement	65
COMPONENT DIAGNOSIS	45	IPDM E/R (INTELLIGENT POWER DISTRIBUTION MODULE ENGINE ROOM)	65
U1000 CAN COMM CIRCUIT	45	IPDM E/R (INTELLIGENT POWER DISTRIBUTION MODULE ENGINE ROOM) : Diagnosis Procedure	65
Description	45	PUSH-BUTTON IGNITION SWITCH POSITION INDICATOR	67
DTC Logic	45	Description	67
Diagnosis Procedure	45	Component Function Check	67
U1010 CONTROL UNIT (CAN)	46	Diagnosis Procedure	67
DTC Logic	46	Component Inspection	69
Diagnosis Procedure	46	ECU DIAGNOSIS	70
B2553 IGNITION RELAY	47	BCM (BODY CONTROL MODULE)	70
Description	47	Reference Value	70
DTC Logic	47	Terminal Layout	74
Diagnosis Procedure	47	Physical Values	75
B260A IGNITION RELAY	49	Wiring Diagram	93
Description	49	Fail Safe	101
DTC Logic	49	DTC Inspection Priority Chart	103
Diagnosis Procedure	49	DTC Index	105
B2611 ACC RELAY	50	IPDM E/R (INTELLIGENT POWER DISTRIBUTION MODULE ENGINE ROOM)	108
Description	50	Reference Value	108
DTC Logic	50	Terminal Layout	109
Diagnosis Procedure	50	Physical Values	109
B2614 ACC RELAY CIRCUIT	52	Wiring Diagram	114
Description	52	Fail Safe	119
DTC Logic	52	DTC Index	121
Diagnosis Procedure	52	SYMPTOM DIAGNOSIS	122
Component Inspection (Accessory Relay)	53	POWER DISTRIBUTION SYSTEM SYMPTOMS	122
B2615 BLOWER RELAY CIRCUIT	55	Symptom Table	122
Description	55	ON-VEHICLE MAINTENANCE	123
DTC Logic	55	PRE-INSPECTION FOR DIAGNOSTIC	123
Diagnosis Procedure	55	Basic Inspection	123
Component Inspection (Blower Relay)	56	ON-VEHICLE REPAIR	124
B2616 IGNITION RELAY CIRCUIT	58	BCM (BODY CONTROL MODULE)	124
Description	58	Removal and Installation	124
DTC Logic	58		
Diagnosis Procedure	58		
Component Inspection (Ignition Relay)	59		
B2618 BCM	61		
Description	61		
DTC Logic	61		
Diagnosis Procedure	61		

RELAY CONTROL SYSTEM

< FUNCTION DIAGNOSIS >

[IPDM E/R]

FUNCTION DIAGNOSIS

RELAY CONTROL SYSTEM

System Diagram

INFOID:000000003071944

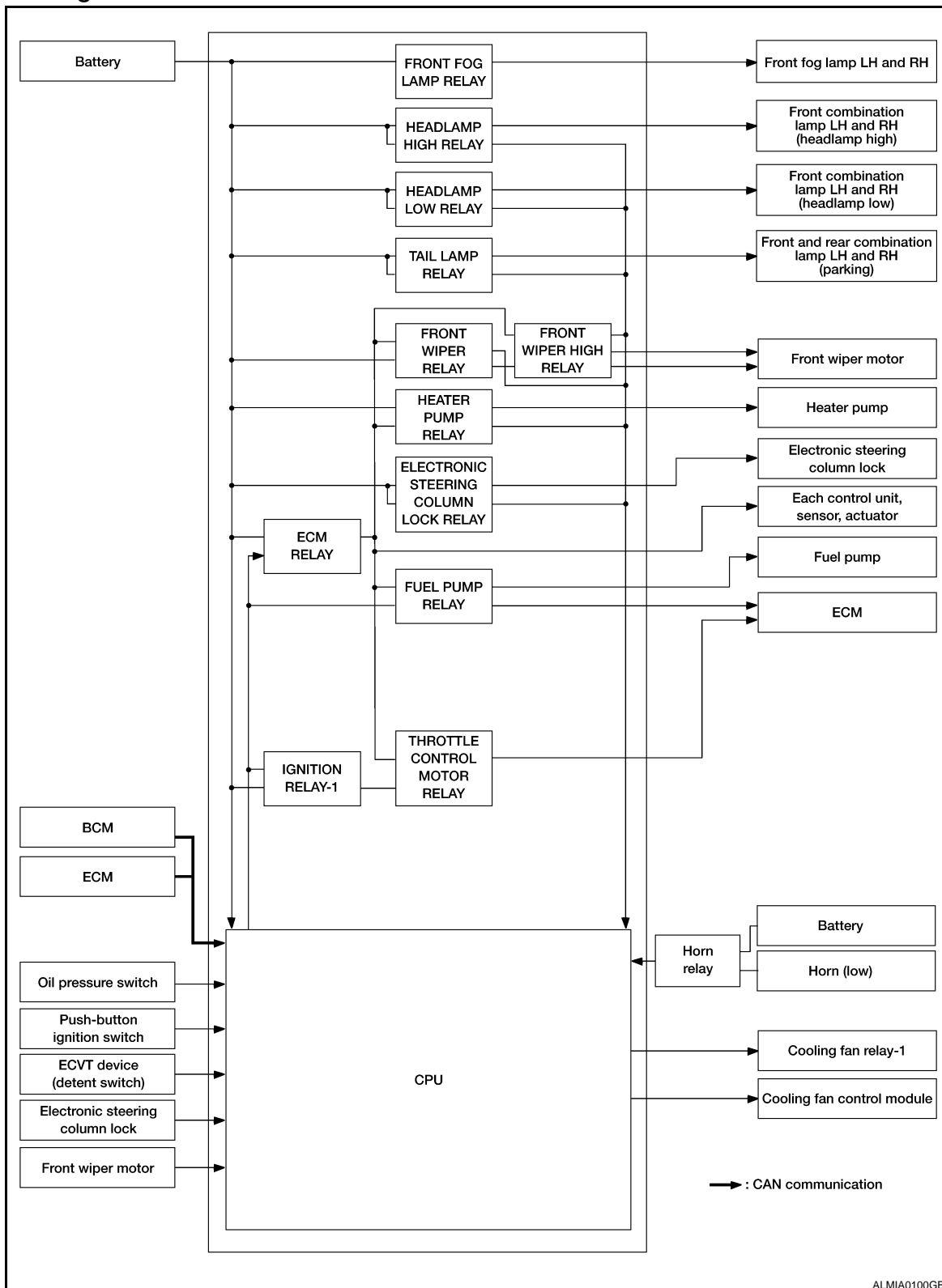

ALMIA0100GB

A
B
C
D
E
F
G
H
I
J
K
L
PCS
N
O
P

RELAY CONTROL SYSTEM

< FUNCTION DIAGNOSIS >

[IPDM E/R]

System Description

INFOID:000000003071946

IPDM E/R activates the internal control circuit to perform the relay ON-OFF control according to the input signals from various sensors and the request signals received from control units via CAN communication.

CAUTION:

IPDM E/R integrated relays cannot be removed.

Control relay	Input/output	Transmit unit	Control part	Reference page
<ul style="list-style-type: none"> Headlamp low relay Headlamp high relay 	<ul style="list-style-type: none"> Low beam request signal High beam request signal 	BCM (CAN)	<ul style="list-style-type: none"> Headlamp low Headlamp High 	EXL-34 EXL-32
Front fog lamp relay	Front fog lamp request signal	BCM (CAN)	Front fog lamps	EXL-36
Tail lamp relay	Position light request signal	BCM (CAN)	<ul style="list-style-type: none"> Parking lamp License plate lamp Tail lamp Illuminations 	EXL-38
<ul style="list-style-type: none"> Front wiper relay Front wiper high relay 	Front wiper request signal	BCM (CAN)	Front wiper	WW-36
	Front wiper auto stop signal	Front wiper motor		
Electronic steering column lock relay	Electronic steering column lock relay signal	BCM (CAN)	Electronic steering column lock unit	STC-7
	Electronic steering column lock unit condition signal	Electronic steering column lock unit		
	ECVT device (Detent switch) signal	ECVT device (Detent switch)		
Heater pump relay	Heater pump request signal	ECM (CAN)	Heater pump	HAC-84
Ignition relay-1	Ignition switch ON signal	BCM (CAN)	Ignition relay-1	BCS-6
	Vehicle speed signal	Combination meter (CAN)		
	Push-button ignition switch	Push-button ignition switch		
Fuel pump relay	Fuel pump request signal	ECM	Fuel pump	EC-380
ECM relay	ECM relay control signal	ECM	ECM relay	EC-118
Throttle control motor relay	Throttle control motor relay signal	ECM	Throttle control motor relay	EC-353
Cooling fan relay-1	Cooling fan request signal	ECM (CAN)	Cooling fan relay-1	EC-59

Component Parts Location

INFOID:000000003071946

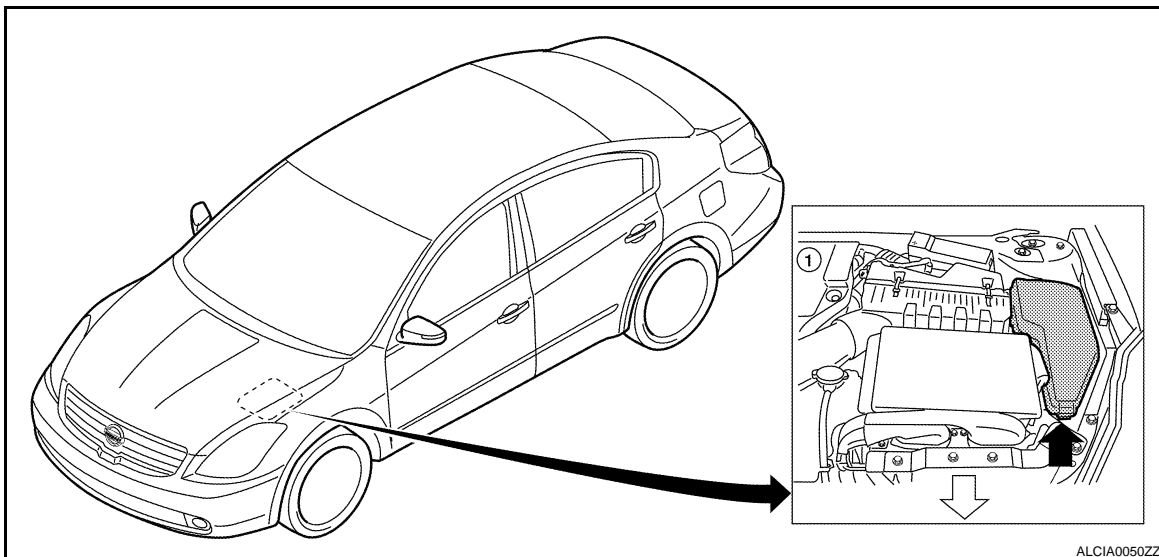

ALC1A0050ZZ

RELAY CONTROL SYSTEM

< FUNCTION DIAGNOSIS >

[IPDM E/R]

1. IPDM E/R E16, E17, E18, E200,
E201, F10

A

B

C

D

E

F

G

H

I

J

K

L

PCS

N

O

P

POWER CONTROL SYSTEM

System Diagram

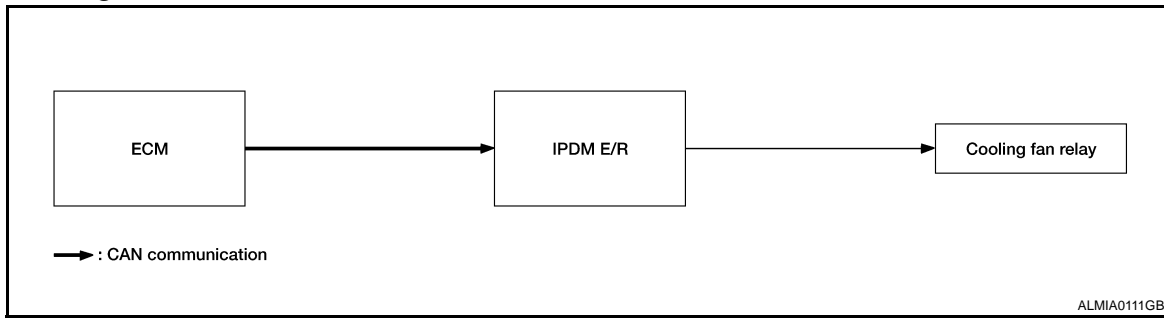

System Description

INFOID:000000003071948

COOLING FAN CONTROL

IPDM E/R controls cooling fans according to the status of the cooling fan speed request signal received from ECM via CAN communication. Refer to [EC-376, "Description"](#).

SIGNAL BUFFER SYSTEM

System Diagram

INFOID:000000003071949

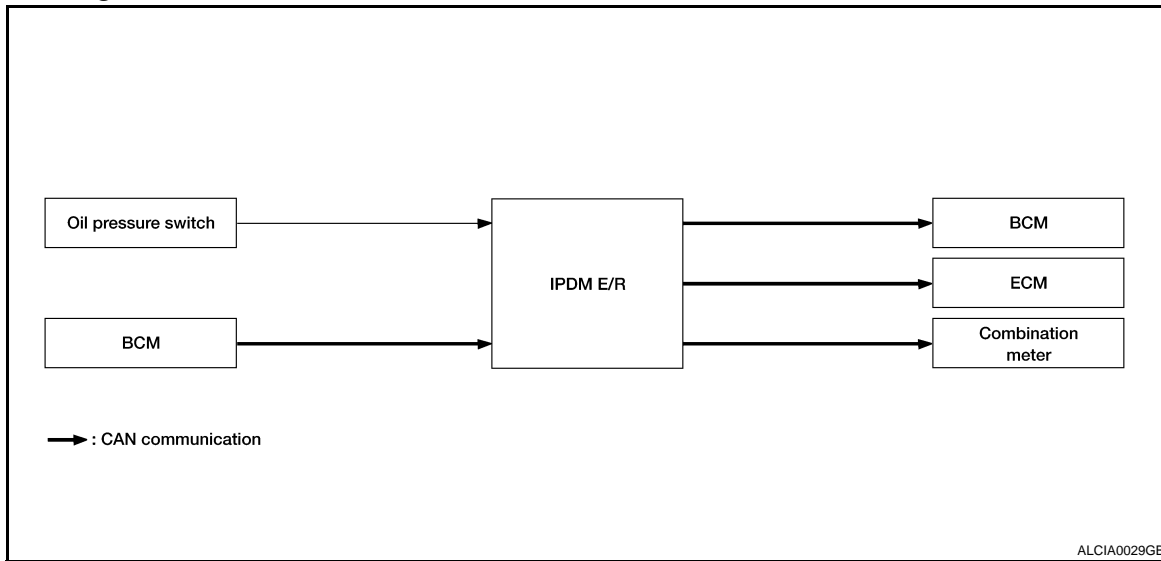

System Description

INFOID:000000003071950

- IPDM E/R reads the status of the oil pressure switch and transmits the oil pressure switch signal to BCM via CAN communication. Refer to [PCS-7, "System Description"](#).
- IPDM E/R receives the rear window defogger status signal from BCM via CAN communication and transmits it to ECM via CAN communication. Refer to [PCS-7, "System Description"](#).

A
B
C
D
E
F
G
H
I
J
K
L
N
O
P

PCS

POWER CONSUMPTION CONTROL SYSTEM

System Diagram

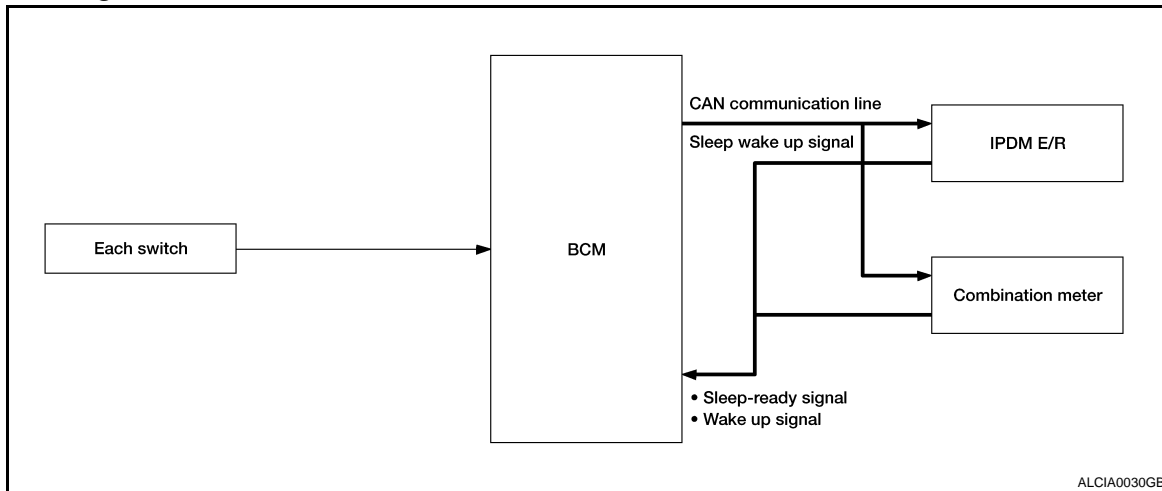

System Description

INFOID:000000003071952

OUTLINE

- IPDM E/R incorporates a power consumption control function that reduces the power consumption according to the vehicle status.
- IPDM E/R changes its status (control mode) with the sleep wake up signal received from BCM via CAN communication.

Normal mode (wake-up)

- CAN communication is normally performed with other control units.
- Individual unit control by IPDM E/R is normally performed.

Low power consumption mode (sleep)

- Low power consumption control is active.
- CAN transmission is stopped.

SLEEP MODE ACTIVATION

- IPDM E/R judges that the sleep-ready conditions are fulfilled when the ignition switch is OFF and none of the conditions below are present. Then it transmits a sleep-ready signal (ready) to BCM via CAN communication.
 - Front wiper fail-safe operation
 - Outputting signals to actuators
 - Switches or relays operating
 - Auto active test is starting
 - Emergency OFF
 - Output requests are being received from control units via CAN communication.
- IPDM E/R stops CAN communication and enters the low power consumption mode when it receives a sleep wake up signal (sleep) from BCM and the sleep-ready conditions are fulfilled.

WAKE-UP OPERATION

- IPDM E/R changes from the low power consumption mode to the normal mode when it receives a sleep wake-up signal (wake up) from BCM or any of the following conditions is fulfilled. In addition, it transmits a sleep-ready signal (not-ready) to BCM via CAN communication to report the CAN communication start.
 - Ignition switch ON
 - An output request is received from a control unit via CAN communication.

POWER CONSUMPTION CONTROL SYSTEM

< FUNCTION DIAGNOSIS >

[IPDM E/R]

Component Parts Location

INFOID:000000003071953

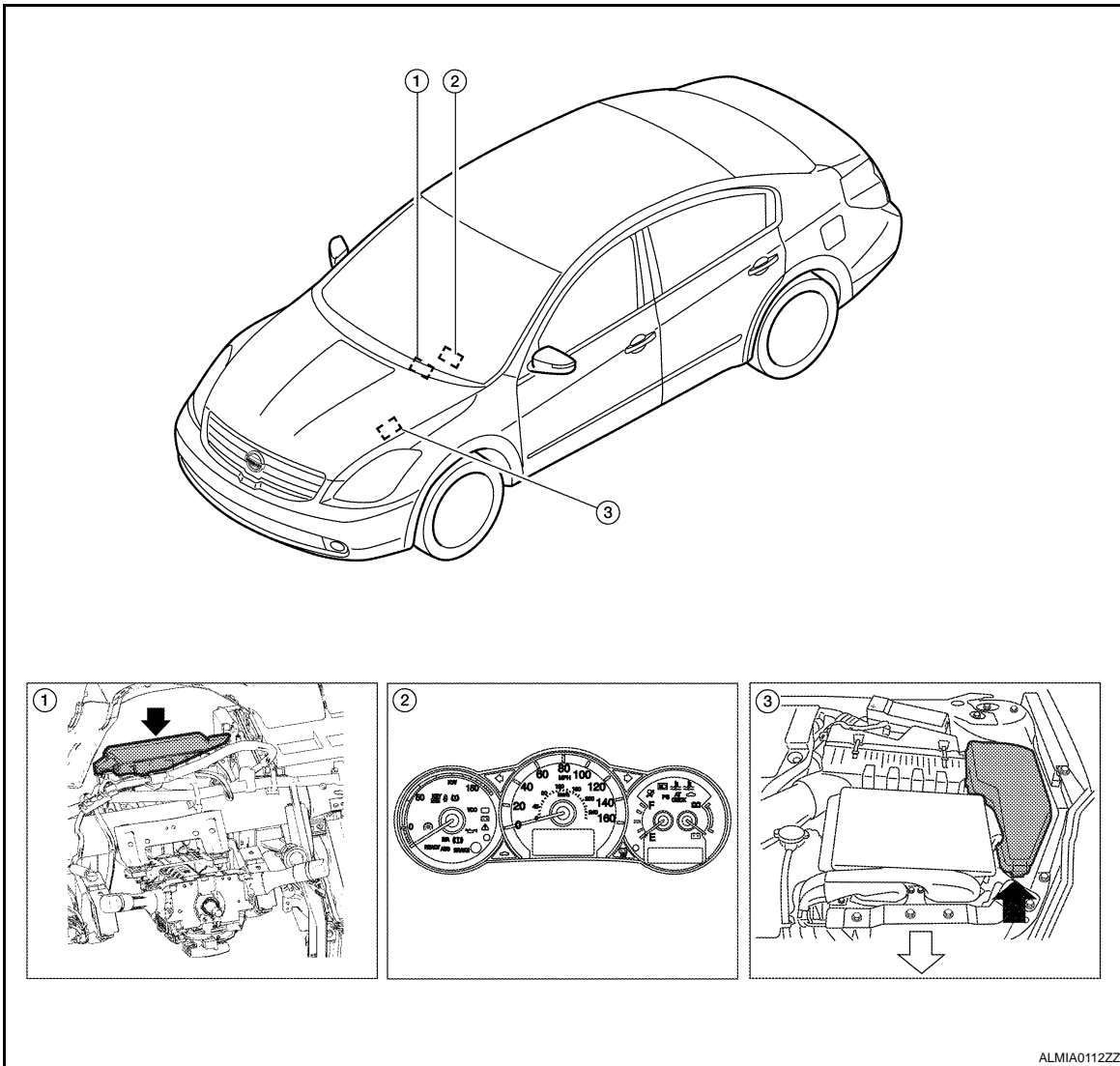

1. BCM (view with instrument panel re-
moved)
2. Combination meter
3. IPDM E/R

A
B
C
D
E
F
G
H
I
J
K
L

PCS

N
O
P

DIAGNOSIS SYSTEM (IPDM E/R)

Diagnosis Description

INFOID:000000003071954

AUTO ACTIVE TEST

Description

In auto active test mode, the IPDM E/R sends a drive signal to the following systems to check their operation.

- Oil pressure warning lamp
- Front wiper (LO, HI)
- Parking lamps
- License plate lamps
- Tail lamps
- Front fog lamps (if equipped)
- Headlamps (LO, HI)
- Heater pump
- Cooling fans

Operation Procedure

1. Close the hood and lift the wiper arms from the windshield. (Prevent windshield damage due to wiper operation)

NOTE:

When auto active test is performed with hood opened, sprinkle water on windshield before hand.

2. Turn ignition switch OFF.
3. Turn the ignition switch ON, and within 20 seconds, press the front door switch LH 10 times. Then turn the ignition switch OFF.

CAUTION:

Close front door RH.

4. Turn the ignition switch ON within 10 seconds. After that the horn sounds once and the auto active test starts.
5. The oil pressure warning lamp starts blinking when the auto active test starts.
6. After a series of the following operations is repeated 3 times, auto active test is completed.

NOTE:

When auto active test mode has to be cancelled halfway through test, turn ignition switch OFF.

CAUTION:

- If auto active test mode cannot be actuated, check door switch system. Refer to [DLK-52, "Component Function Check"](#).
- Do not start the engine.

Inspection in Auto Active Test Mode

DIAGNOSIS SYSTEM (IPDM E/R)

< FUNCTION DIAGNOSIS >

[IPDM E/R]

When auto active test mode is actuated, the following 6 steps are repeated 3 times.

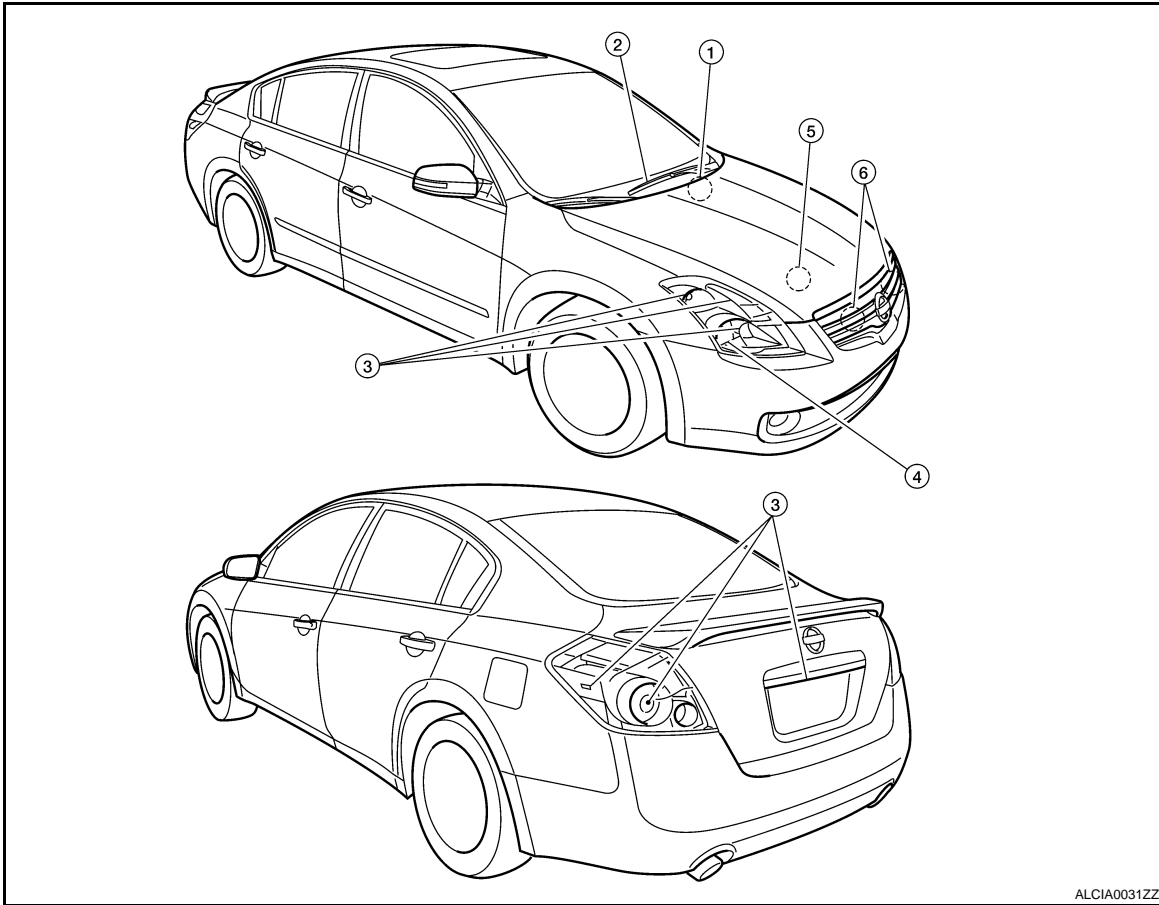

Operation sequence	Inspection Location	Operation
1	Oil pressure warning lamp	Blinks continuously during operation of auto active test
2	Front wiper	LO for 5 seconds → HI for 5 seconds
3	<ul style="list-style-type: none"> • Parking lamps • License plate lamps • Tail lamps • Front fog lamps (if equipped) 	10 seconds
4	Headlamps	LO ↔ HI 5 times
5	Heater pump	ON ↔ OFF 5 times
6*	Cooling fans	MID for 5 seconds → HI for 5 seconds

*: Outputs duty ratio of 50% for 5 seconds → duty ratio of 100% for 5 seconds on the cooling fan control module.

A
B
C
D
E
F
G
H
I
J
K
L
PCS
N
O
P

DIAGNOSIS SYSTEM (IPDM E/R)

< FUNCTION DIAGNOSIS >

[IPDM E/R]

Concept of auto active test

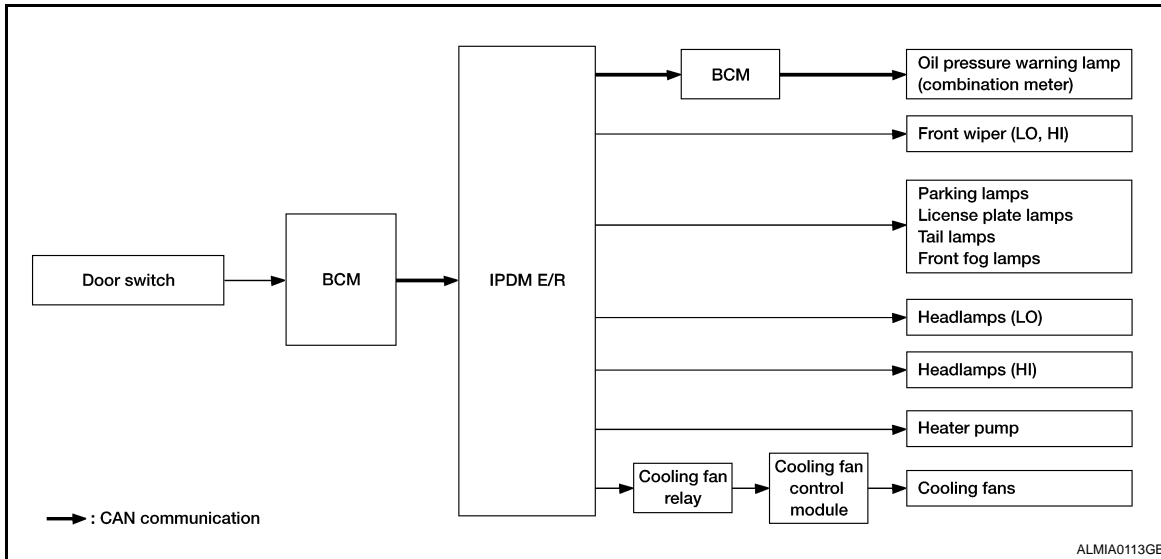

- IPDM E/R starts the auto active test with the door switch signals transmitted by BCM via CAN communication. Therefore, the CAN communication line between IPDM E/R and BCM is considered normal if the auto active test starts successfully.
- The auto active test facilitates troubleshooting if any systems controlled by IPDM E/R cannot be operated.

Diagnosis chart in auto active test mode

Symptom	Inspection contents	Possible cause
Any of the following components do not operate <ul style="list-style-type: none"> • Parking lamps • License plate lamps • Tail lamps • Front fog lamps (if equipped) • Headlamp (HI, LO) • Front wiper 	Perform auto active test. Does the applicable system operate?	YES BCM signal input circuit
		NO <ul style="list-style-type: none"> • Lamp or motor • Lamp or motor ground circuit • Harness or connector between IPDM E/R and applicable system • IPDM E/R
Heater pump does not operate	Perform auto active test. Does the heater pump operate?	YES <ul style="list-style-type: none"> • Combination meter signal input circuit • CAN communication signal between combination meter and ECM • CAN communication signal between ECM and IPDM E/R
		NO <ul style="list-style-type: none"> • Heater pump • Harness or connector between IPDM E/R and magnet clutch • IPDM E/R
Oil pressure warning lamp does not operate	Perform auto active test. Does the oil pressure warning lamp blink?	YES <ul style="list-style-type: none"> • Harness or connector between IPDM E/R and oil pressure switch • Oil pressure switch • IPDM E/R
		NO <ul style="list-style-type: none"> • CAN communication signal between IPDM E/R and BCM • CAN communication signal between BCM and combination meter • Combination meter

DIAGNOSIS SYSTEM (IPDM E/R)

< FUNCTION DIAGNOSIS >

[IPDM E/R]

Symptom	Inspection contents	Possible cause
Cooling fan does not operate	Perform auto active test. Does the cooling fan operate?	YES
		NO

- ECM signal input circuit
- CAN communication signal between ECM and IPDM E/R

- Cooling fan
- Harness or connector between cooling fan and cooling fan relays
- Cooling fan relays
- Harness or connector between IPDM E/R and cooling fan relays
- IPDM E/R

CONSULT - III Function (IPDM E/R)

INFOID:000000003071955

APPLICATION ITEM

CONSULT-III performs the following functions via CAN communication with IPDM E/R.

Diagnosis mode	Description
ECU Identification	Allows confirmation of IPDM E/R part number.
Self Diagnostic Result	Displays the diagnosis results judged by IPDM E/R.
Data Monitor	Displays the real-time input/output data from IPDM E/R input/output data.
Active Test	IPDM E/R can provide a drive signal to electronic components to check their operations.
CAN Diag Support Monitor	The results of transmit/receive diagnosis of CAN communication can be read.

SELF DIAGNOSTIC

Refer to [PCS-32, "DTC Index"](#).

DATA MONITOR

Monitor item

Monitor Item [Unit]	MAIN SIGNALS	Description
RADFAN REQ [%]	×	Displays the value of the cooling fan speed signal received from ECM via CAN communication.
TAIL&CLR REQ [OFF/ON]	×	Displays the status of the position light request signal received from BCM via CAN communication.
HL LO REQ [OFF/ON]	×	Displays the status of the low beam request signal received from BCM via CAN communication.
HL HI REQ [OFF/ON]	×	Displays the status of the high beam request signal received from BCM via CAN communication.
FR FOG REQ [OFF/ON]	×	Displays the status of the front fog lamp request signal received from BCM via CAN communication.
FR WIP REQ [STOP/1LOW/LOW/HI]	×	Displays the status of the front wiper request signal received from BCM via CAN communication.
WIP AUTO STOP [STOP P/ACT P]	×	Displays the status of the front wiper auto stop signal judged by IPDM E/R.
WIP PROT [OFF/BLOCK]	×	Displays the status of the front wiper fail-safe operation judged by IPDM E/R.
IGN RLY1 -REQ [OFF/ON]		Displays the status of the ignition switch ON signal received from BCM via CAN communication.
IGN RLY [OFF/ON]	×	Displays the status of the ignition relay judged by IPDM E/R.

A
B
C
D
E
F
G
H
I
J
K
L
N
O
P

PCS

DIAGNOSIS SYSTEM (IPDM E/R)

< FUNCTION DIAGNOSIS >

[IPDM E/R]

Monitor Item [Unit]	MAIN SIG- NALS	Description
PUSH SW [OFF/ON]		Displays the status of the push-button ignition switch judged by IPDM E/R.
DETENT SW [OFF/ON]		Displays the status of the CVT device (detention switch) judged by IPDM E/R.
S/L RLY -REQ [OFF/ON]		Displays the status of the electronic steering column lock relay request received from BCM via CAN communication.
S/L STATE [LOCK/UNLK/UNKWN]		Displays the status of the electronic steering column lock judged by IPDM E/R.
DTRL REQ [OFF]		NOTE: This item is displayed, but cannot be monitored.
OIL P SW [OPEN/CLOSE]		Displays the status of the oil pressure switch judged by IPDM E/R.
THFT HRN REQ [OFF/ON]		Displays the status of the theft warning horn request signal received from BCM via CAN communication.
HORN CHIRP [OFF/ON]		Displays the status of the horn reminder signal received from BCM via CAN communication.
CRNRNG LMP REQ [OFF]		NOTE: This item is displayed, but cannot be monitored.

ACTIVE TEST

Test item

Test item	Operation	Description
CORNERING LAMP	OFF	NOTE: This item is displayed, but cannot be monitored.
	LH	
	RH	
HORN	ON	Operates horn relay for 20 ms.
FRONT WIPER	OFF	OFF
	LO	Operates the front wiper relay.
	HI	Operates the front wiper relay and front wiper high relay.
MOTOR FAN	1	OFF
	2	Outputs 50% pulse duty signal (PWM signal) to the cooling fan control module.
	3	Outputs 80% pulse duty signal (PWM signal) to the cooling fan control module.
	4	Outputs 100% pulse duty signal (PWM signal) to the cooling fan control module.
EXTERNAL LAMPS	OFF	OFF
	TAIL	Operates the tail lamp relay.
	LO	Operates the headlamp low relay.
	HI	Operates the headlamp low relay and ON/OFF the headlamp high relay at 1 second intervals.
	FOG	Operates the front fog lamp relay

U1000 CAN COMM CIRCUIT

< COMPONENT DIAGNOSIS >

[IPDM E/R]

COMPONENT DIAGNOSIS

U1000 CAN COMM CIRCUIT

Description

INFOID:000000003071956

Refer to [LAN-7, "System Description"](#).

DTC Logic

INFOID:000000003071957

DTC DETECTION LOGIC

DTC	CONSULT-III display description	DTC Detection Condition	Possible cause
U1000	CAN COMM CIRCUIT	When IPDM E/R cannot communicate CAN communication signal continuously for 2 seconds or more	In CAN communication system, any item (or items) of the following listed below is malfunctioning. <ul style="list-style-type: none">• Transmission• Receiving (ECM)• Receiving (BCM)• Receiving (Combination meter)

DTC CONFIRMATION PROCEDURE

Diagnosis Procedure

INFOID:000000003071958

1. PERFORM SELF DIAGNOSTIC

1. Turn ignition switch ON and wait for 2 second or more.
2. Check "SELF-DIAG RESULTS" of IPDM E/R.

Is "CAN COMM CIRCUIT" displayed?

- YES >> Refer to [PCS-15, "DTC Logic"](#).
NO >> Refer to [GI-42, "Intermittent Incident"](#).

A
B
C
D
E
F
G
H
I
J
K
L
N
O
P

PCS

B2098 IGNITION RELAY ON STUCK

< COMPONENT DIAGNOSIS >

[IPDM E/R]

B2098 IGNITION RELAY ON STUCK

Description

INFOID:000000003071959

- IPDM E/R operates the ignition relay when it receives an ignition switch ON signal from BCM via CAN communication.
- Turn the ignition relay OFF by pressing the push-button ignition switch once when the vehicle speed is 4 km/h (2.5 MPH) or less.
- Turn the ignition relay OFF with the following operation when the vehicle speed is more than 4 km/h (2.5 MPH) or when an abnormal condition occurs in CAN communication from the combination meter (Emergency OFF)
 - Press and hold the push-button ignition switch for 2 seconds or more.
 - Press the push-button ignition switch 3 time within 1.5 seconds.

NOTE:

The ignition relay does not turn ON for 3 seconds after emergency OFF even if the push-button ignition switch is pressed.

DTC Logic

INFOID:000000003071960

DTC DETECTION LOGIC

DTC	CONSULT-III display description	DTC Detection Condition	Possible causes
B2098	IGN RELAY ON	The ignition relay ON is detected for 1 second at ignition switch OFF (CPU monitors the status at the contact and excitation coil circuits of the ignition relay inside it)	Ignition relay malfunction

Diagnosis Procedure

INFOID:000000003071961

1. PERFORM SELF DIAGNOSIS

1. Turn the ignition switch ON.
2. Erase "SELF-DIAG RESULTS" of IPDM E/R.
3. Turn ignition switch OFF, and wait for 1 second or more.
4. Turn the ignition switch ON. Check "SELF-DIAG RESULTS" again.

Is "IGN RELAY ON" displayed?

- YES >> Replace IPDM E/R. Refer to [PCS-34, "Removal and Installation"](#).
NO >> Refer to [GI-42, "Intermittent Incident"](#).

B2099 IGNITION RELAY OFF STUCK

< COMPONENT DIAGNOSIS >

[IPDM E/R]

B2099 IGNITION RELAY OFF STUCK

Description

INFOID:000000003071962

- IPDM E/R operates the ignition relay when it receives an ignition switch ON signal from BCM via CAN communication.
- Turn the ignition relay OFF by pressing the push-button ignition switch once when the vehicle speed is 4 km/h (2.5 MPH) or less.
- Turn the ignition relay OFF with the following operation when the vehicle speed is more than 4 km/h (2.5 MPH) or when an abnormal condition occurs in CAN communication from the combination meter (Emergency OFF)
 - Press and hold the push-button ignition switch for 2 seconds or more.
 - Press the push-button ignition switch 3 time within 1.5 seconds.

NOTE:

The ignition relay does not turn ON for 3 seconds after emergency OFF even if the push-button ignition switch is pressed.

DTC Logic

INFOID:000000003071963

DTC DETECTION LOGIC

DTC	CONSULT-III display description	DTC Detection Condition	Possible causes
B2099	IGN RELAY OFF	The ignition relay OFF is detected for 1 second at ignition switch ON (CPU monitors the status at the contact and excitation coil circuits of the ignition relay inside it)	Ignition relay malfunction

Diagnosis Procedure

INFOID:000000003071964

1. PERFORM SELF DIAGNOSIS

1. Turn the ignition switch ON.
2. Erase "SELF-DIAG RESULTS".
3. Turn ignition switch OFF.
4. Turn the ignition switch ON. Check "SELF-DIAG RESULTS" again.

Is "IGN RELAY OFF" displayed?

- YES >> Replace IPDM E/R.
 NO >> Refer to [GI-42, "Intermittent Incident"](#).

A
B
C
D
E
F
G
H
I
J
K
L
N
O
P

PCS

POWER SUPPLY AND GROUND CIRCUIT

< COMPONENT DIAGNOSIS >

[IPDM E/R]

POWER SUPPLY AND GROUND CIRCUIT

Diagnosis Procedure

INFOID:000000003071965

1. CHECK FUSES AND FUSIBLE LINK

Check that the following IPDM E/R fuses or fusible link are not blown.

Terminal No.	Signal name	Fuses and fusible link No.
1, 2	Battery power supply	B, E, F
—		42
—		43

Is the fuse blown?

- YES >> Replace the blown fuse or fusible link after repairing the affected circuit.
 NO >> GO TO 2

2. CHECK POWER SUPPLY CIRCUIT

- Turn ignition switch OFF.
- Disconnect IPDM E/R.
- Check voltage between IPDM E/R harness connector and ground.

Terminals		Voltage (V) (Approx.)
(+)	(-)	
IPDM E/R		Ground
Connector	Terminal	
E16	1 2	
		Battery voltage

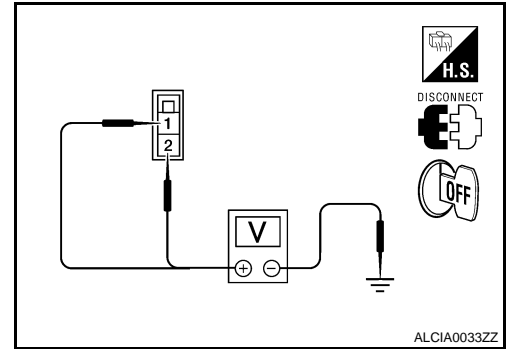

Is the measurement value normal?

- YES >> GO TO 3
 NO >> Repair or replace harness.

3. CHECK GROUND CIRCUIT

Check continuity between IPDM E/R harness connectors and ground.

IPDM E/R		Ground	Continuity
Connector	Terminal		
E18 (A)	12	Ground	Yes
E17 (B)	41		

Does continuity exist?

- YES >> Inspection End.
 NO >> Repair or replace harness.

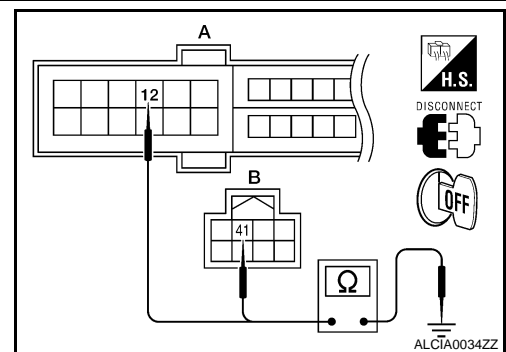

IPDM E/R (INTELLIGENT POWER DISTRIBUTION MODULE ENGINE ROOM)

< ECU DIAGNOSIS >

[IPDM E/R]

ECU DIAGNOSIS

IPDM E/R (INTELLIGENT POWER DISTRIBUTION MODULE ENGINE ROOM)

Reference Value

INFOID:000000003071966

VALUES ON THE DIAGNOSIS TOOL

Monitor Item	Condition		Value/Status
RADFAN REQ	Engine idle speed	Changes depending on engine coolant temperature, air conditioner operation status, vehicle speed, etc.	0 - 100 %
TAIL&CLR REQ	Lighting switch OFF		OFF
	Lighting switch 1ST, 2ND, HI or AUTO (Light is illuminated)		ON
HL LO REQ	Lighting switch OFF		OFF
	Lighting switch 2ND HI or AUTO (Light is illuminated)		ON
HL HI REQ	Lighting switch OFF		OFF
	Lighting switch HI		ON
FR FOG REQ	Lighting switch 2ND or AUTO (Light is illuminated)	Front fog lamp switch OFF	OFF
		<ul style="list-style-type: none"> • Front fog lamp switch ON • Daytime light activated (Canada only) 	ON
FR WIP REQ	Ignition switch ON	Front wiper switch OFF	STOP
		Front wiper switch INT	1LOW
		Front wiper switch LO	LOW
		Front wiper switch HI	HI
WIP AUTO STOP	Ignition switch ON	Front wiper stop position	STOP P
		Any position other than front wiper stop position	ACT P
WIP PROT	Ignition switch ON	Front wiper operates normally	OFF
		Front wiper stops at fail-safe operation	BLOCK
IGN RLY1 -REQ	Ignition switch OFF or ACC		OFF
	Ignition switch ON		ON
IGN RLY	Ignition switch OFF or ACC		OFF
	Ignition switch ON		ON
PUSH SW	Release the push-button ignition switch		OFF
	Press the push-button ignition switch		ON
DETENT SW	Ignition switch ON	<ul style="list-style-type: none"> • Press the selector button with CVT selector lever in P position • CVT selector lever in any position other than P 	OFF
		Release the CVT selector button with CVT selector lever in P position	
S/L RLY -REQ	None of the conditions below are present		OFF
	<ul style="list-style-type: none"> • Open the front door LH after the ignition switch is turned OFF (for a few seconds) • Press the push-button ignition switch when the steering lock is activated 		ON

A
B
C
D
E
F
G
H
I
J
K
L

PCS

N
O
P

IPDM E/R (INTELLIGENT POWER DISTRIBUTION MODULE ENGINE ROOM)

< ECU DIAGNOSIS >

[IPDM E/R]

Monitor Item	Condition	Value/Status
S/L STATE	Steering lock is activated	LOCK
	Steering lock is deactivated	UNLK
	[DTC B210A] is detected	UNKWN
DTRL REQ	NOTE: This item is displayed, but cannot be monitored.	OFF
OIL P SW	Ignition switch OFF, ACC or engine running	OPEN
	Ignition switch ON	CLOSE
THFT HRN REQ	Not operated	OFF
	<ul style="list-style-type: none"> Panic alarm is activated Horn is activated with VEHICLE SECURITY (THEFT WARNING) SYSTEM 	ON
HORN CHIRP	Not operated	OFF
	Door locking with Intelligent Key (horn chirp mode)	ON
CRNRNG LMP REQ	NOTE: This item is displayed, but cannot be monitored.	OFF

Terminal Layout

INFOID:000000003071967

TERMINAL LAYOUT

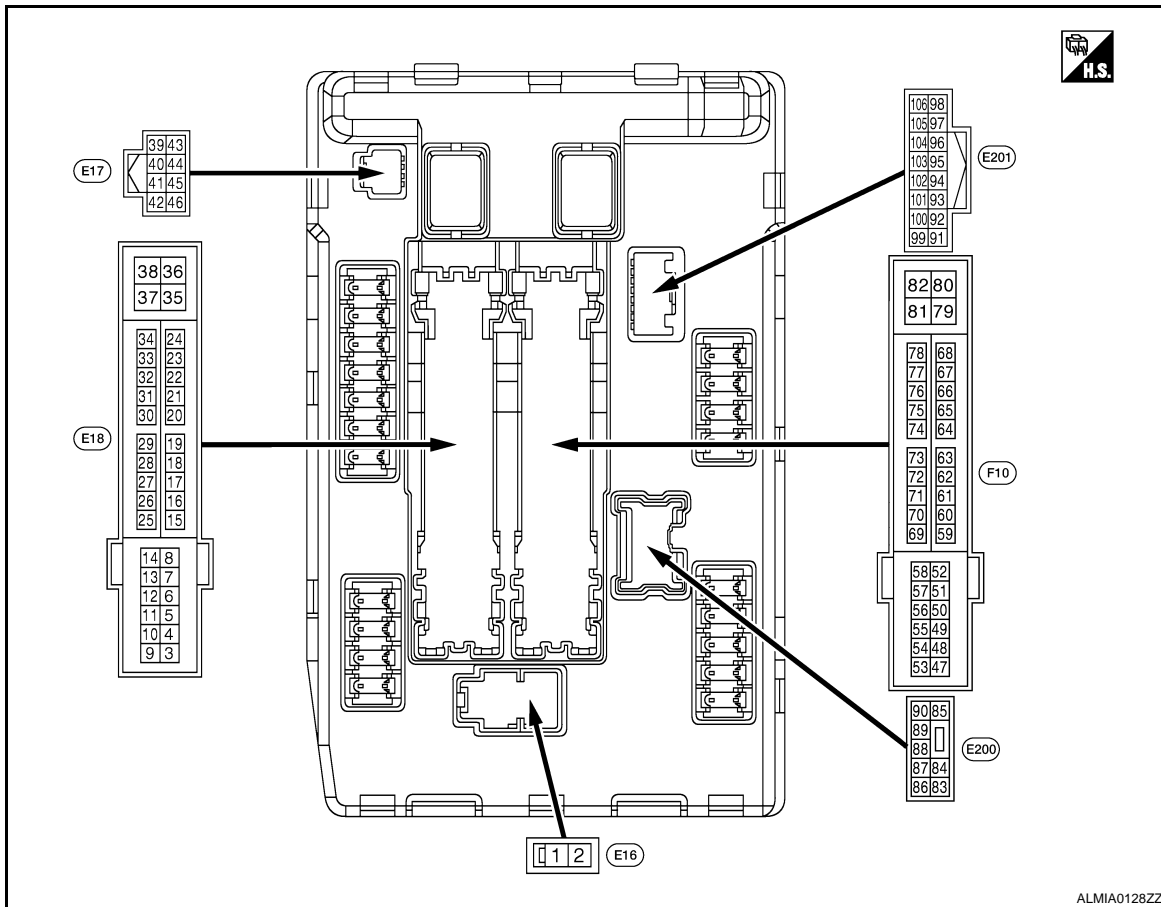

Physical Values

INFOID:000000003071968

PHYSICAL VALUES

IPDM E/R (INTELLIGENT POWER DISTRIBUTION MODULE ENGINE ROOM)

< ECU DIAGNOSIS >

[IPDM E/R]

Terminal No. (Wire color)		Description		Condition		Value (Approx.)
1 (R)	Ground	Battery power supply	Input	Ignition switch OFF		Battery voltage
2 (B/Y)	Ground	Battery power supply	Input	Ignition switch OFF		Battery voltage
4 (L/R)	Ground	Front wiper LO	Output	Ignition switch ON	Front wiper switch OFF	0V
					Front wiper switch LO	Battery voltage
5 (L/B)	Ground	Front wiper HI	Output	Ignition switch ON	Front wiper switch OFF	0V
						Front wiper switch HI
6 (SB)	Ground	Daytime light relay power supply (Canada models only)	Output	Ignition switch OFF		Battery voltage
7 (R/L)	Ground	Tail, license plate lamps & interior lamps	Output	Ignition switch ON	Lighting switch OFF	0V
						Lighting switch 1ST
10 (R/B)	Ground	ECM relay power supply	Output	Ignition switch OFF (For a few seconds after turning ignition switch OFF)		0V
				<ul style="list-style-type: none"> • Ignition switch ON • Ignition switch OFF (More than a few seconds after turning ignition switch OFF) 		Battery voltage
11 (P/L)	Ground	Steering lock unit power supply	Output	Ignition switch OFF	A few seconds after opening the driver door	Battery voltage
				Ignition switch LOCK	Press the push-button ignition switch	Battery voltage
				Ignition switch ACC or ON		0V
12 (B)	Ground	Ground	—	Ignition switch ON		0V
13 (W)	Ground	Fuel pump power supply	Output	Approximately 1 second or more after turning the ignition switch ON		0V
				<ul style="list-style-type: none"> • Approximately 1 second after turning the ignition switch ON • Engine running 		Battery voltage
15 (BR)	Ground	Ignition relay-1 power supply	Output	Ignition switch OFF		0V
				Ignition switch ON		Battery voltage
16 (L/Y)	Ground	Front wiper auto stop	Input	Ignition switch ON	Front wiper stop position	0V
						Any position other than front wiper stop position
19 (L/Y)	Ground	Ignition relay-1 power supply	Output	Ignition switch OFF		0V
				Ignition switch ON		Battery voltage
20 (B/Y)	Ground	Ambient sensor ground	—	Ignition switch ON		0V
21 (O/B)	Ground	Ambient sensor	—	Ignition switch ON		5V
22 (W/R)	Ground	Refrigerent pressure sensor ground	—	Ignition switch ON		0V

A
B
C
D
E
F
G
H
I
J
K
L
PCS
N
O
P

IPDM E/R (INTELLIGENT POWER DISTRIBUTION MODULE ENGINE ROOM)

< ECU DIAGNOSIS >

[IPDM E/R]

Terminal No. (Wire color)		Description		Condition	Value (Approx.)
+	-	Signal name	Input/ Output		
23 (B/R)	Ground	Refrigerent pressure sensor	—	<ul style="list-style-type: none"> Ignition switch ON (READY) Both A/C switch and blower motor switch ON (electric compressor operates) 	1.0 - 4.0V
24 (BR/W)	Ground	Refrigerent pressure sensor power supply	—	Ignition switch ON	5V
25 (G/R)	Ground	Ignition relay-1 power supply	Output	Ignition switch OFF	0V
				Ignition switch ON	Battery voltage
27 (BR/W)	Ground	Ignition relay monitor	Input	Ignition switch OFF or ACC	Battery voltage
				Ignition switch ON	0V
28 (BR)	Ground	Push-button ignition switch	Input	Press the push-button ignition switch	0V
				Release the push-button ignition switch	Battery voltage
31 (G/W)	Ground	Ignition relay power supply	Output	Ignition switch OFF	0V
				Ignition switch ON	Battery voltage
32 (LG)	Ground	Electronic steering column lock unit condition-1	Input	Electronic steering column lock is activated	0V
				Electronic steering column lock is deactivated	Battery voltage
33 (W)	Ground	Electronic steering column lock unit condition-2	Input	Electronic steering column lock is activated	Battery voltage
				Electronic steering column lock is deactivated	0V
39 (P)	—	CAN-L	Input/ Output	—	—
40 (L)	—	CAN-H	Input/ Output	—	—
41 (B)	Ground	Ground	—	Ignition switch ON	0V
42 (SB)	Ground	Cooling fan relay-1 control	Input	Ignition switch OFF or ACC	0V
				Ignition switch ON	0.7V
43 (G/B)	Ground	ECVT device (Detention switch)	Input	Press the ECVT selector button (ECVT selector lever P)	Battery voltage
				<ul style="list-style-type: none"> ECVT selector lever in any position other than P Release the ECVT selector button (ECVT selector lever P) 	0V
44 (G/W)	Ground	Horn relay control	Input	The horn is deactivated	Battery voltage
				The horn is activated	0V
45 (L/O)	Ground	Anti theft horn relay control	Input	The horn is deactivated	Battery voltage
				The horn is activated	0V
48 (R)	Ground	Heater pump relay power supply	Output	Engine running	Heater pump OFF
				Heater pump ON (Heater pump is operating)	0V

IPDM E/R (INTELLIGENT POWER DISTRIBUTION MODULE ENGINE ROOM)

< ECU DIAGNOSIS >

[IPDM E/R]

Terminal No. (Wire color)		Description		Condition	Value (Approx.)
		Signal name	Input/ Output		
+	-				
49 (B/R)	Ground	ECM relay power supply	Output	Ignition switch OFF (For a few seconds after turning ignition switch OFF)	0V
				<ul style="list-style-type: none"> • Ignition switch ON • Ignition switch OFF (More than a few seconds after turning ignition switch OFF) 	Battery voltage
51 (LG)	Ground	Ignition relay power supply	Output	Ignition switch OFF	0V
				Ignition switch ON	Battery voltage
53 (R/W)	Ground	ECM relay power supply	Output	Ignition switch OFF (For a few seconds after turning ignition switch OFF)	0V
				<ul style="list-style-type: none"> • Ignition switch ON • Ignition switch OFF (More than a few seconds after turning ignition switch OFF) 	Battery voltage
54 (G/W)	Ground	Throttle control motor relay power supply	Output	Ignition switch OFF (For a few seconds after turning ignition switch OFF)	0V
				<ul style="list-style-type: none"> • Ignition switch ON • Ignition switch OFF (More than a few seconds after turning ignition switch OFF) 	Battery voltage
55 (W/L)	Ground	ECM power supply	Output	Ignition switch OFF	Battery voltage
56 (R/Y)	Ground	Ignition relay power supply	Output	Ignition switch OFF	0V
				Ignition switch ON	Battery voltage
57 (O)	Ground	Ignition relay power supply	Output	Ignition switch OFF	0V
				Ignition switch ON	Battery voltage
69 (W/B)	Ground	ECM relay control	Output	Ignition switch OFF (For a few seconds after turning ignition switch OFF)	Battery voltage
				<ul style="list-style-type: none"> • Ignition switch ON • Ignition switch OFF (More than a few seconds after turning ignition switch OFF) 	0 - 1.5V
70 (O)	Ground	Throttle control motor relay control	Output	Ignition switch ON → OFF	0 - 1.0V ↓ Battery voltage ↓ 0V
				Ignition switch ON	0 - 1.0V
75 (P/L)	Ground	Oil pressure switch	Input	Ignition switch ON	Engine stopped ↓ Engine running
				0V	Battery voltage
77 (B/R)	Ground	Fuel pump relay control	Output	<ul style="list-style-type: none"> • Approximately 1 second after turning the ignition switch ON • Engine running 	0 - 1.0V
				Approximately 1 second or more after turning the ignition switch ON	Battery voltage
83 (R/Y)	Ground	Headlamp LO (RH)	Output	Ignition switch ON	Lighting switch OFF ↓ Lighting switch 2ND
				0V	Battery voltage

A
B
C
D
E
F
G
H
I
J
K
L

PCS

N
O
P

IPDM E/R (INTELLIGENT POWER DISTRIBUTION MODULE ENGINE ROOM)

< ECU DIAGNOSIS >

[IPDM E/R]

Terminal No. (Wire color)		Description		Condition		Value (Approx.)
+	-	Signal name	Input/ Output			
84 (L)	Ground	Headlamp LO (LH)	Output	Ignition switch ON	Lighting switch OFF	0V
					Lighting switch 2ND	Battery voltage
86 (W/R)	Ground	Front fog lamp (RH)	Output	Lighting switch 2ND	<ul style="list-style-type: none"> • Front fog lamp switch ON • Daytime light activated (Canada only) 	Battery voltage
					Front fog lamp switch OFF	0V
87 (L/Y)	Ground	Front fog lamp (LH)	Output	Lighting switch 2ND	<ul style="list-style-type: none"> • Front fog lamp switch ON • Daytime light activated (Canada only) 	Battery voltage
					Front fog lamp switch OFF	0V
88 (R/W)	Ground	Washer pump power supply	Output	Ignition switch ON		Battery voltage
89 (L/W)	Ground	Headlamp HI (RH)	Output	Ignition switch ON	<ul style="list-style-type: none"> • Lighting switch HI • Lighting switch PASS 	Battery voltage
					Lighting switch OFF	0V
90 (G)	Ground	Headlamp HI (LH)	Output	Ignition switch ON	<ul style="list-style-type: none"> • Lighting switch HI • Lighting switch PASS 	Battery voltage
					Lighting switch OFF	0V
91 (LG/ R)	Ground	Parking lamp (RH)	Output	Ignition switch ON	Lighting switch 1ST	Battery voltage
					Lighting switch OFF	0V
92 (LG/ B)	Ground	Parking lamp (LH)	Output	Ignition switch ON	Lighting switch 1ST	Battery voltage
					Lighting switch OFF	0V
97 (V)	Ground	Cooling fan control	Output	Engine idling		0-5V
99 (BR/ W)	Ground	Ambient sensor ground	—	Ignition switch ON		0V
100 (SB)	Ground	Ambient sensor	—	Ignition switch ON		5V
101 (W)	Ground	Refrigerent pressure sensor ground	—	Ignition switch ON		0V
102 (R)	Ground	Refrigerent pressure sensor	—	<ul style="list-style-type: none"> • Ignition switch ON (READY) • Both A/C switch and blower motor switch ON (electric compressor operates) 		1.0 - 4.0V
103 (P)	Ground	Refrigerent pressure sensor power supply	—	Ignition switch ON		5V
105 (V)	Ground	Daytime light relay control (Canada only)	Output	Ignition switch ON	Daytime light system active	Battery voltage
				Ignition switch ON	Daytime light system inactive	0V

IPDM E/R (INTELLIGENT POWER DISTRIBUTION MODULE ENGINE ROOM)

< ECU DIAGNOSIS >

[IPDM E/R]

Wiring Diagram

INFOID:000000003071969

IPDM E/R (INTELLIGENT POWER DISTRIBUTION MODULE ENGINE ROOM)

◊ FL : WITH FRONT FOG LAMPS
◊ N : CANADA

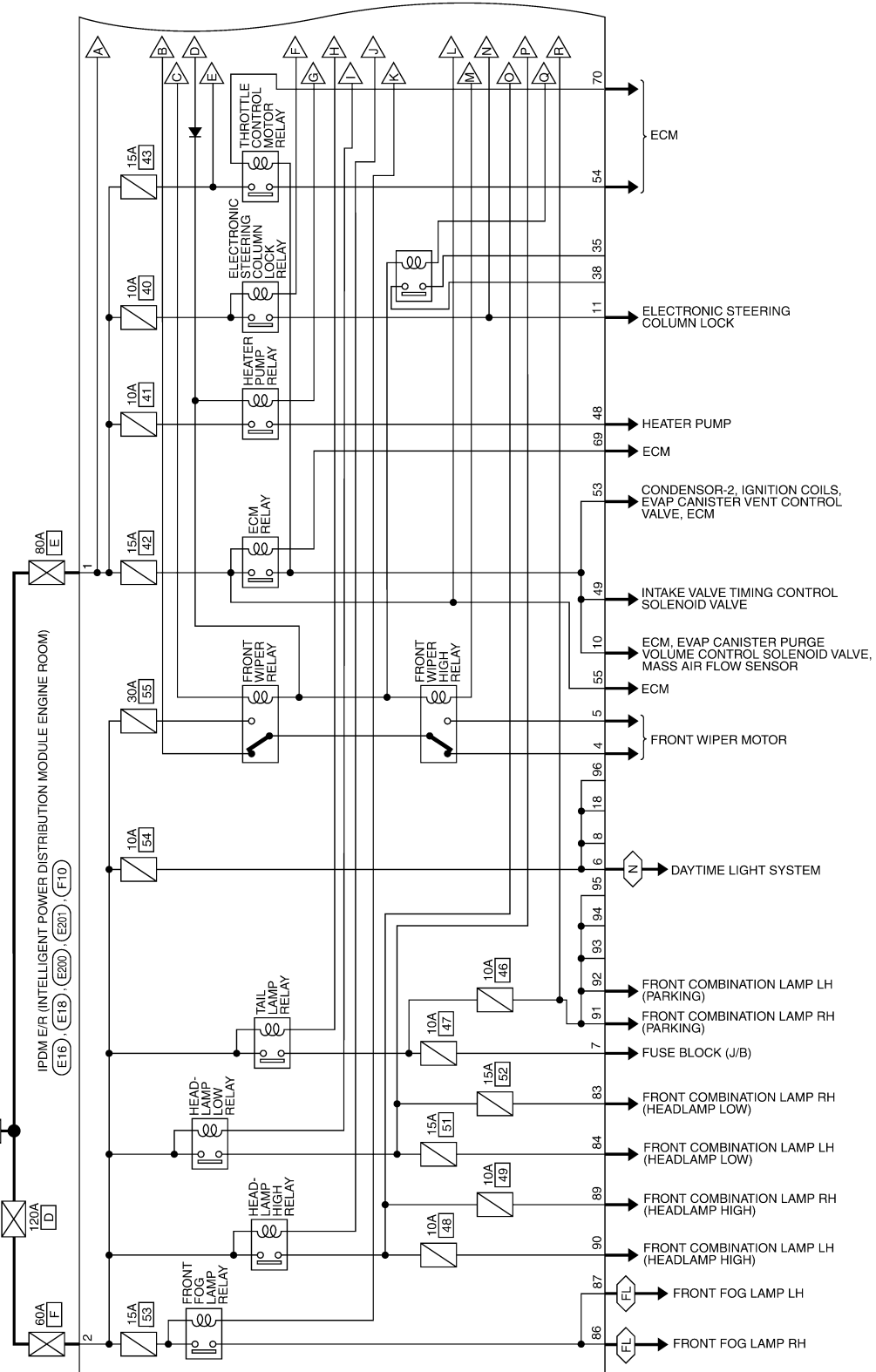

AWMWA0193G

A
B
C
D
E
F
G
H
I
J
K
L
N
O
P

PCS

IPDM E/R (INTELLIGENT POWER DISTRIBUTION MODULE ENGINE ROOM)

< ECU DIAGNOSIS >

[IPDM E/R]

 : CANADA
 : DATA LINE

IPDM E/R (INTELLIGENT POWER DISTRIBUTION MODULE ENGINE ROOM)

(E17) (E18) (E200) (E201) (E10)

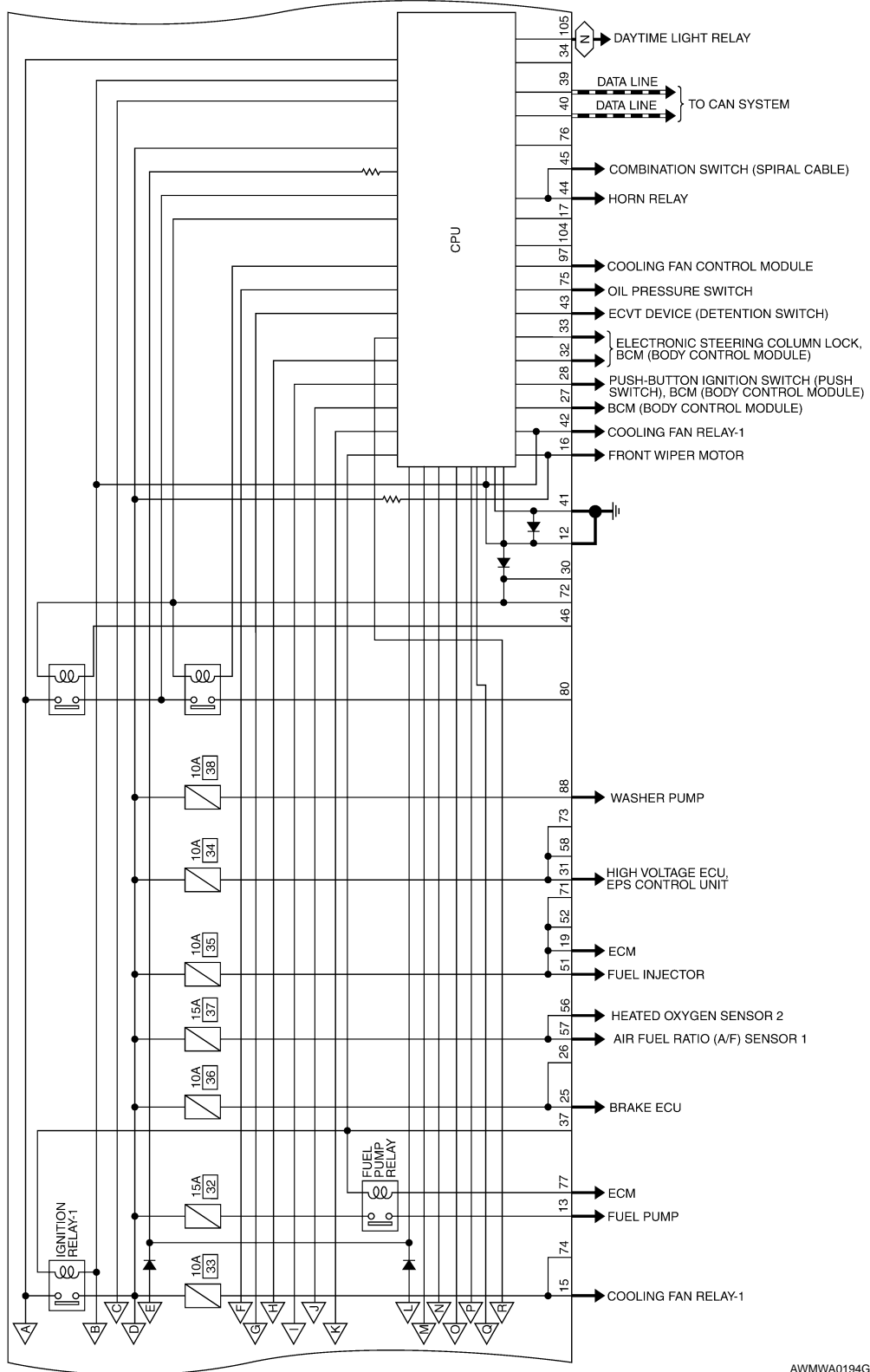

AWMWA0194G

IPDM E/R (INTELLIGENT POWER DISTRIBUTION MODULE ENGINE ROOM)

< ECU DIAGNOSIS >

[IPDM E/R]

A
B
C
D
E
F
G
H
I
J
K
L
N
O
P

IPDM E/R
(INTELLIGENT POWER
DISTRIBUTION MODULE
ENGINE ROOM)
(E18) (E20)

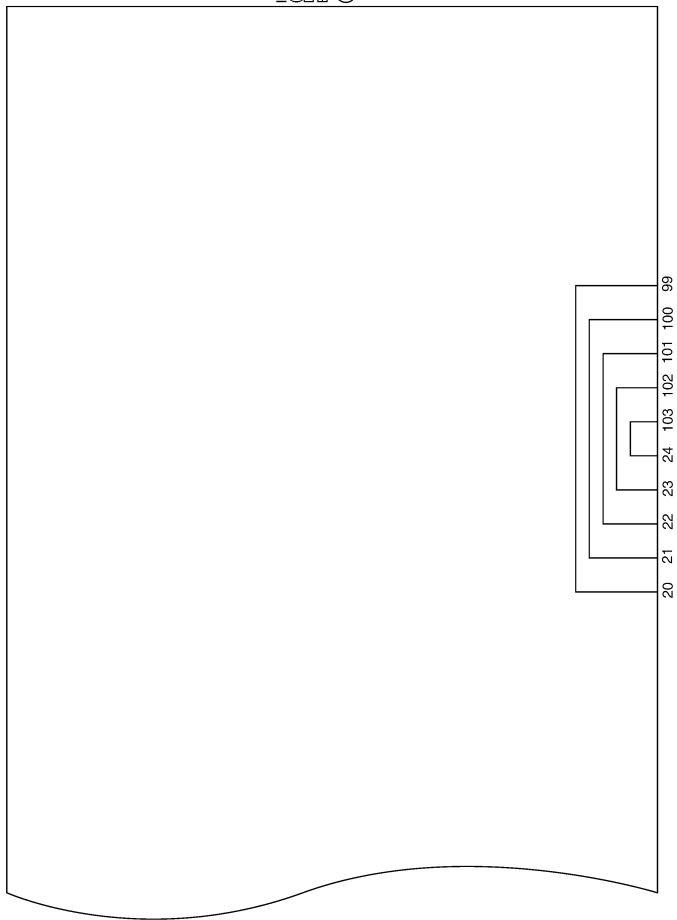

PCS

ALMWA0033GE

IPDM E/R (INTELLIGENT POWER DISTRIBUTION MODULE ENGINE ROOM) CONNECTORS

Connector No.	E16
Connector Name	IPDM E/R (INTELLIGENT POWER DISTRIBUTION MODULE ENGINE ROOM)
Connector Color	BLACK



Terminal No.	Color of Wire	Signal Name
1	R	F/L_MAIN
2	B/Y	F/L_USM

Connector No.	E17
Connector Name	IPDM E/R (INTELLIGENT POWER DISTRIBUTION MODULE ENGINE ROOM)
Connector Color	WHITE

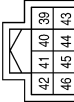

Terminal No.	Color of Wire	Signal Name
39	P	CAN-L
40	L	CAN-H
41	B	S-GND
42	SB	MOTOR_FAN_RLY_MID
43	G/B	DETENT_SW
44	G/W	HORN_RLY
45	L/O	HORN_SW
46	-	-

Connector No.	E18
Connector Name	IPDM E/R (INTELLIGENT POWER DISTRIBUTION MODULE ENGINE ROOM)
Connector Color	WHITE

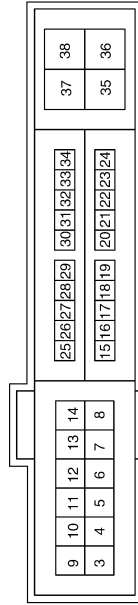

Terminal No.	Color of Wire	Signal Name
3	-	-
4	L/R	FR_WIPER_LO
5	L/B	FR_WIPER_HI
6	SB	DTRL
7	R/L	TAIL/ILLUMI

Terminal No.	Color of Wire	Signal Name
8	-	-
9	-	-
10	R/B	ECM_VB
11	P/L	ESCL
12	B	P-GND
13	W	FUEL_PUMP
14	-	-
15	BR	START_IG-E/R
16	L/Y	WIPER_AUTOSTOP
17	-	-
18	-	-
19	L/Y	BCM_IGNSW
20	B/Y	AMB_SENS_GND-E/R
21	O/B	AMB_SENS_SIG-E/R
22	W/R	PD_SENS_GND-E/R

Terminal No.	Color of Wire	Signal Name
23	B/R	PD_SENS_SIG-E/R
24	BR/W	PD_SENS_PWR-E/R
25	G/R	ABS_ECU
26	-	-
27	BR/W	IGN_SIGNAL
28	BR	PUSH_START_SW
29	-	-
30	-	-
31	G/W	REV_RLY
32	LG	SL_CONDITION_1
33	W	SL_CONDITION_2
34	-	-
35	-	-
36	-	-
37	-	-
38	-	-

A
B
C
D
E
F
G
H
I
J
K
L
N
O
P

Connector No.	E201
Connector Name	IPDM E/R (INTELLIGENT POWER DISTRIBUTION MODULE ENGINE ROOM)
Connector Color	WHITE

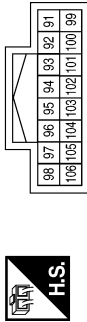

Terminal No.	Color of Wire	Signal Name
91	LG/R	CLEARANCE_RH
92	LG/B	CLEARANCE_LH
93	-	-
94	-	-
95	-	-
96	-	-
97	V	MOTOR_FAN_PWM
98	-	-
99	BR/W	AMB_SENS_GND-FEM
100	SB	AMB_SENS_SIG-FEM
101	W	PD_SENS_GND-FEM
102	R	PD_SENS_SIG-FEM
103	P	PD_SENS_PWR-FEM
104	-	-
105	V	DTRL_RLY
106	-	-

Connector No.	E200
Connector Name	IPDM E/R (INTELLIGENT POWER DISTRIBUTION MODULE ENGINE ROOM)
Connector Color	WHITE

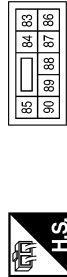

Terminal No.	Color of Wire	Signal Name
83	R/Y	HEADLAMP_LO_RH
84	L	HEADLAMP_LO_LH
85	-	-
86	W/R	FR_FOG_LAMP_RH
87	L/Y	FR_FOG_LAMP_LH
88	R/W	WASHER_MTR
89	L/W	HEADLAMP_HI_RH
90	G	HEADLAMP_HI_LH

PCS

ALMIA0077GB

Terminal No.	Color of Wire	Signal Name
64	-	-
65	-	-
66	-	-
67	-	-
68	-	-
69	W/B	SSOF
70	O	MOTRLY
71	-	-
72	-	-
73	-	-
74	-	-
75	P/L	OIL_PRESSURE_SW
76	-	-
77	B/R	FPR
78	-	-
79	-	-
80	-	-
81	-	-
82	-	-

Terminal No.	Color of Wire	Signal Name
47	-	-
48	R	ENG_SOL
49	B/R	ENG_SOL
50	-	-
51	LG	INJECTOR_#1
52	-	-
53	R/W	IGN_COIL
54	G/W	ETC
55	W/L	ECM_BAT
56	R/Y	O2_SENS_#1
57	O	O2_SENS_#2
58	-	-
59	-	-
60	-	-
61	-	-
62	-	-
63	-	-

Connector No.	F10
Connector Name	IPDM E/R (INTELLIGENT POWER DISTRIBUTION MODULE ENGINE ROOM)
Connector Color	WHITE

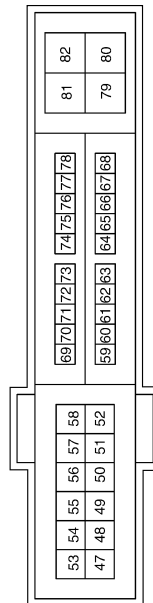

ALMIA0078GB

INFOID:000000003071970

Fail Safe

CAN COMMUNICATION CONTROL

When CAN communication with ECM and BCM is impossible, IPDM E/R performs fail-safe control. After CAN communication recovers normally, it also returns to normal control.

If No CAN Communication Is Available With ECM

IPDM E/R (INTELLIGENT POWER DISTRIBUTION MODULE ENGINE ROOM)

< ECU DIAGNOSIS >

[IPDM E/R]

Control part	Fail-safe in operation
Cooling fan	<ul style="list-style-type: none"> • Signals cooling fans ON when the ignition switch is turned ON • Signals cooling fans OFF when the ignition switch is turned OFF
Heater pump	Heater pump relay OFF

If No CAN Communication Is Available With BCM

Control part	Fail-safe in operation
Headlamp	<ul style="list-style-type: none"> • Turns ON the headlamp low relay when the ignition switch is turned ON • Turns OFF the headlamp low relay when the ignition switch is turned OFF • Headlamp high relay OFF
<ul style="list-style-type: none"> • Parking lamps • License plate lamps • Illuminations • Tail lamps 	<ul style="list-style-type: none"> • Turns ON the tail lamp relay when the ignition switch is turned ON • Turns OFF the tail lamp relay when the ignition switch is turned OFF
Front wiper	<ul style="list-style-type: none"> • The status just before activation of fail-safe control is maintained until the ignition switch is turned OFF while the front wiper is operating at LO or HI speed. • The wiper is operated at LO speed until the ignition switch is turned OFF if the fail-safe control is activated while the front wiper is set in the INT mode and the front wiper motor is operating.
Front fog lamps (if equipped)	Front fog lamp relay OFF
Horn	Horn OFF
Ignition relay	The status just before activation of fail-safe is maintained.
Electronic steering column lock unit	Electronic steering column lock relay OFF

IGNITION RELAY MALFUNCTION DETECTION FUNCTION

- IPDM E/R monitors the voltage at the contact circuit and excitation coil circuit of the ignition relay inside it.
- IPDM E/R judges the ignition relay error if the voltage differs between the contact circuit and the excitation coil circuit.
- If the ignition relay cannot turn OFF due to contact seizure, it activates the tail lamp relay for 10 minutes to alert the user to the ignition relay malfunction when the ignition switch is turned OFF.

DTC	Ignition switch	Ignition relay	Tail lamp relay
—	ON	ON	—
—	OFF	OFF	—
B2098: IGN RELAY ON	OFF	ON	ON (10 minutes)
B2099: IGN RELAY OFF	ON	OFF	—

NOTE:

The tail lamp turns OFF when the ignition switch is turned ON.

FRONT WIPER CONTROL

IPDM E/R detects front wiper stop position by a front wiper auto stop signal.

When a front wiper auto stop signal is in the conditions listed below, IPDM E/R stops power supply to wiper after repeating a front wiper 10 second activation and 20 second stop five times.

Ignition switch	Front wiper switch	Auto stop signal
ON	OFF	Front wiper stop position signal cannot be input 10 seconds.
	ON	The signal does not change for 10 seconds.

NOTE:

This operation status can be confirmed on the IPDM E/R “Data Monitor” that displays “BLOCK” for the item “WIP PROT” while the wiper is stopped.

STARTER MOTOR PROTECTION FUNCTION

IPDM E/R turns OFF the starter control relay to protect the starter motor when the starter control relay remains active for 90 seconds.

A
B
C
D
E
F
G
H
I
J
K
L
N
O
P

IPDM E/R (INTELLIGENT POWER DISTRIBUTION MODULE ENGINE ROOM)

< ECU DIAGNOSIS >

[IPDM E/R]

DTC Index

INFOID:000000003071971

CONSULT-III display	Fail-safe	TIME ^{NOTE}		Refer to
No DTC is detected. further testing may be required.	—	—	—	—
U1000: CAN COMM CIRCUIT	×	CRNT	1 – 39	PCS-15
B2098: IGN RELAY ON	×	CRNT	1 – 39	PCS-16
B2099: IGN RELAY OFF	—	CRNT	1 – 39	PCS-17
B2108: STRG LCK RELAY ON	—	CRNT	1 – 39	SEC-85
B2109: STRG LCK RELAY OFF	—	CRNT	1 – 39	SEC-86
B210A: STRG LCK STATE SW	—	CRNT	1 – 39	SEC-87

NOTE:

The details of TIME display are as follows.

- CRNT: The malfunctions that are detected now
- 1 - 39: The number is indicated when it is normal at present and a malfunction was detected in the past. It increases like 0 → 1 → 2 ... 38 → 39 after returning to the normal condition whenever IGN OFF → ON. It is fixed to 39 until the self-diagnosis results are erased if it is over 39. It returns to 0 when a malfunction is detected again in the process.

PRECAUTION

PRECAUTIONS

Precaution for Supplemental Restraint System (SRS) "AIR BAG" and "SEAT BELT PRE-TENSIONER"

INFOID:000000003071972

The Supplemental Restraint System such as "AIR BAG" and "SEAT BELT PRE-TENSIONER", used along with a front seat belt, helps to reduce the risk or severity of injury to the driver and front passenger for certain types of collision. This system includes seat belt switch inputs and dual stage front air bag modules. The SRS system uses the seat belt switches to determine the front air bag deployment, and may only deploy one front air bag, depending on the severity of a collision and whether the front occupants are belted or unbelted. Information necessary to service the system safely is included in the SR and SB section of this Service Manual.

WARNING:

- To avoid rendering the SRS inoperative, which could increase the risk of personal injury or death in the event of a collision which would result in air bag inflation, all maintenance must be performed by an authorized NISSAN/INFINITI dealer.
- Improper maintenance, including incorrect removal and installation of the SRS, can lead to personal injury caused by unintentional activation of the system. For removal of Spiral Cable and Air Bag Module, see the SR section.
- Do not use electrical test equipment on any circuit related to the SRS unless instructed to in this Service Manual. SRS wiring harnesses can be identified by yellow and/or orange harnesses or harness connectors.

Precautions For High-Voltage System

INFOID:000000003071973

Refer to [GI-24. "Precautions For High-Voltage System"](#).

Precaution for Procedure without Cowl Top Cover

INFOID:000000003071974

When performing the procedure after removing cowl top cover, cover the lower end of windshield with urethane, etc.

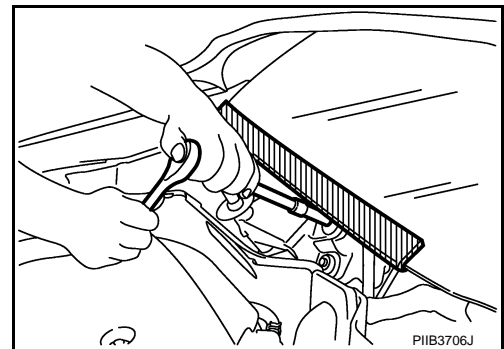

A
B
C
D
E
F
G
H
I
J
K
L
N
O
P

PCS

ON-VEHICLE REPAIR

IPDM E/R (INTELLIGENT POWER DISTRIBUTION MODULE ENGINE ROOM)

Removal and Installation

INFOID:000000003071975

REMOVAL

1. Disconnect the 12-volt battery cable from the negative terminal.
2. Remove the IPDM E/R cover (1) while pressing the pawl (A) at the rear end of the IPDM E/R cover (1).

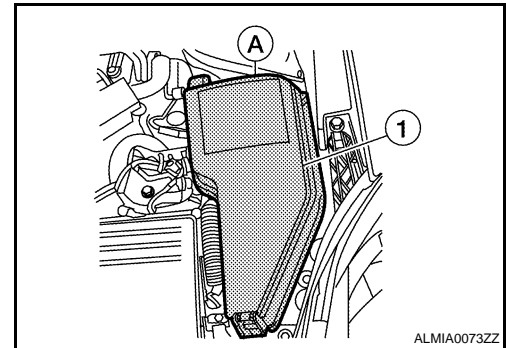

3. Disconnect the harness connectors from the IPDM E/R.

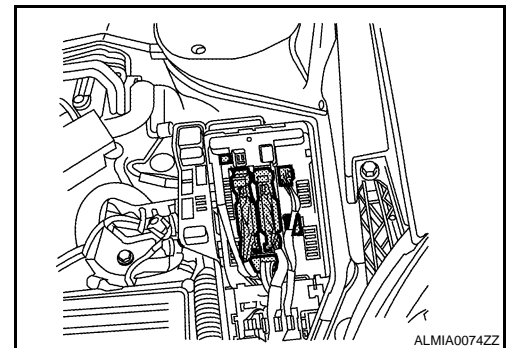

4. While depressing the tabs (A) remove the IPDM E/R (1) from the vehicle.

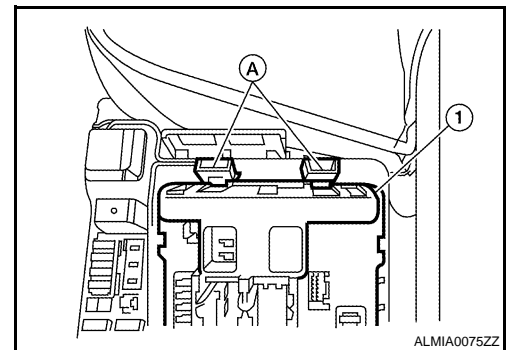

INSTALLATION

Installation is in the reverse order of removal.

DIAGNOSIS AND REPAIR WORKFLOW

< BASIC INSPECTION >

[POWER DISTRIBUTION SYSTEM]

BASIC INSPECTION

DIAGNOSIS AND REPAIR WORKFLOW

Work Flow

INFOID:000000003071976

OVERALL SEQUENCE

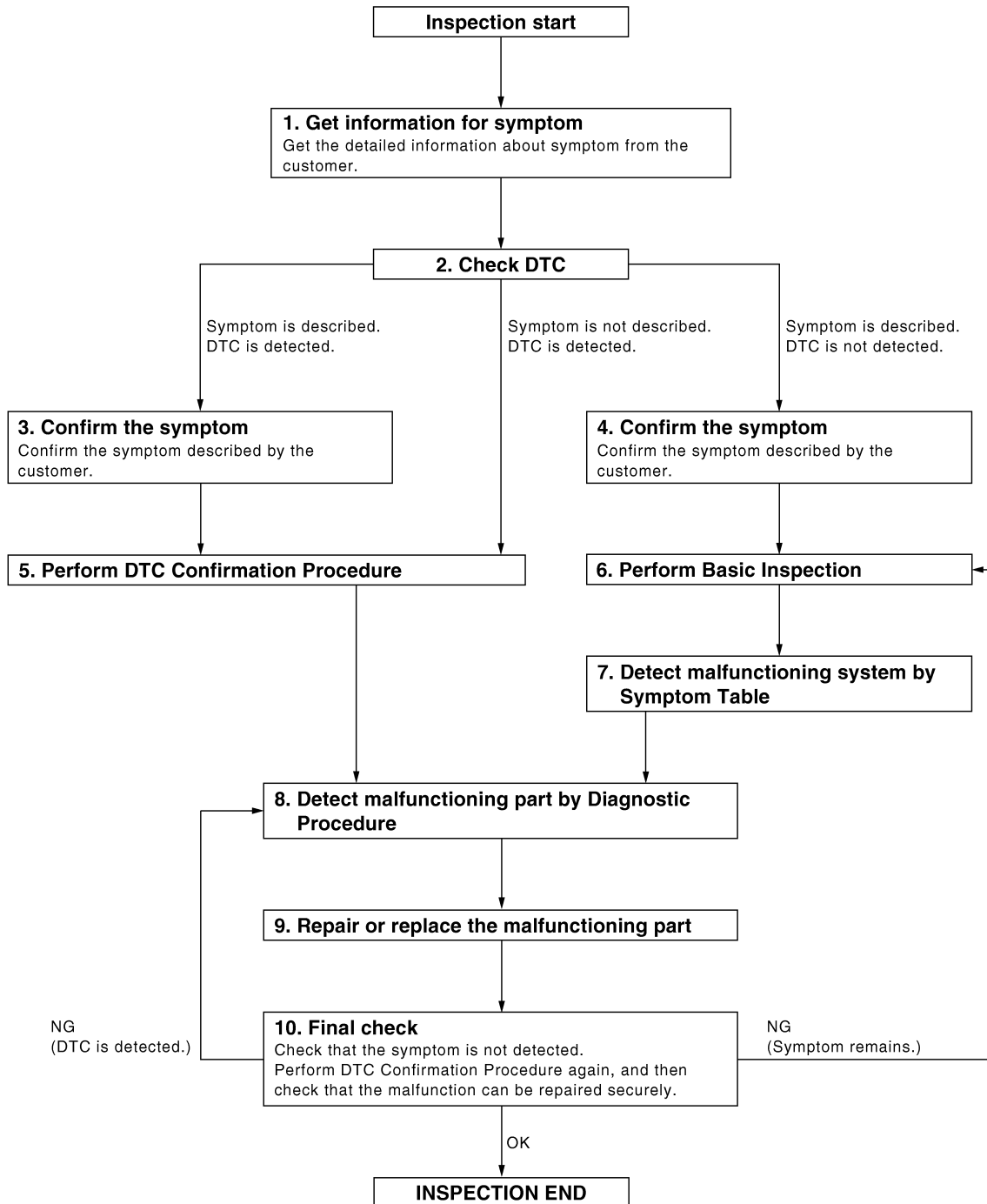

DETAILED FLOW

A
B
C
D
E
F
G
H
I
J
K
L
PCS
N
O
P

DIAGNOSIS AND REPAIR WORKFLOW

< BASIC INSPECTION >

[POWER DISTRIBUTION SYSTEM]

1. GET INFORMATION FOR SYMPTOM

Get the detailed information from the customer about the symptom (the condition and the environment when the incident/malfunction occurred).

>> GO TO 2

2. CHECK DTC

1. Check DTC.
2. Perform the following procedure if DTC is displayed.
 - Record DTC and freeze frame data.
 - Erase DTC.
 - Study the relationship between the cause detected by DTC and the symptom described by the customer.
3. Check related service bulletins for information.

Is any symptom described and any DTC detected?

Symptom is described, DTC is displayed>>GO TO 3

Symptom is described, DTC is not displayed>>GO TO 4

Symptom is not described, DTC is displayed>>GO TO 5

3. CONFIRM THE SYMPTOM

Confirm the symptom described by the customer.

Connect CONSULT-III to the vehicle in "DATA MONITOR" mode and check real time diagnosis results.

Verify relationship between the symptom and the condition when the symptom is detected.

>> GO TO 5

4. CONFIRM THE SYMPTOM

Confirm the symptom described by the customer.

Connect CONSULT-III to the vehicle in "DATA MONITOR" mode and check real time diagnosis results.

Verify relationship between the symptom and the condition when the symptom is detected.

>> GO TO 6

5. PERFORM DTC CONFIRMATION PROCEDURE

Perform DTC Confirmation Procedure for the displayed DTC, and then check that DTC is detected again.

At this time, always connect CONSULT-III to the vehicle, and check diagnostic results in real time.

If two or more DTCs are detected, refer to [PCS-103. "DTC Inspection Priority Chart"](#) and determine trouble diagnosis order.

NOTE:

- Freeze frame data is useful if the DTC is not detected.
- Perform Component Function Check if DTC Confirmation Procedure is not included in Service Manual. This simplified check procedure is an effective alternative though DTC cannot be detected during this check. If the result of Component Function Check is NG, it is the same as the detection of DTC by DTC Confirmation Procedure.

Is DTC detected?

YES >> GO TO 8

NO >> Refer to [GI-42. "Intermittent Incident"](#).

6. PERFORM BASIC INSPECTION

Perform [PCS-123. "Basic Inspection"](#).

Inspection End>>GO TO 7

7. DETECT MALFUNCTIONING SYSTEM BY SYMPTOM TABLE

Detect malfunctioning system according to [PCS-122. "Symptom Table"](#) based on the confirmed symptom in step 4, and determine the trouble diagnosis order based on possible causes and symptom.

>> GO TO 8

DIAGNOSIS AND REPAIR WORKFLOW

< BASIC INSPECTION >

[POWER DISTRIBUTION SYSTEM]

8. DETECT MALFUNCTIONING PART BY DIAGNOSTIC PROCEDURE

Inspect according to Diagnostic Procedure of the system.

NOTE:

The Diagnostic Procedure described based on open circuit inspection. A short circuit inspection is also required for the circuit check in the Diagnostic Procedure.

Is malfunctioning part detected?

YES >> GO TO 9

NO >> Check voltage of related BCM terminals using CONSULT-III.

9. REPAIR OR REPLACE THE MALFUNCTIONING PART

1. Repair or replace the malfunctioning part.
2. Reconnect parts or connectors disconnected during Diagnostic Procedure again after repair and replacement.
3. Check DTC. If DTC is displayed, erase it.

>> GO TO 10

10. FINAL CHECK

When DTC was detected in step 2, perform DTC Confirmation Procedure or Component Function Check again, and then check that the malfunction have been fully repaired.

When symptom was described from the customer, refer to confirmed symptom in step 3 or 4 and check that the symptom is not detected.

OK or NG

NG (DTC is detected)>>GO TO 8

NG (Symptom remains)>>GO TO 6

OK >> Inspection End.

A
B
C
D
E
F
G
H
I
J
K
L
N
O
P

PCS

POWER DISTRIBUTION SYSTEM

< FUNCTION DIAGNOSIS >

[POWER DISTRIBUTION SYSTEM]

FUNCTION DIAGNOSIS

POWER DISTRIBUTION SYSTEM

System Description

INFOID:000000003071977

INPUT/OUTPUT SIGNAL CHART

Switch	Input Signal to BCM	BCM system	Actuator
Push-button ignition switch	Push switch	Power distribution system	<ul style="list-style-type: none"> • Ignition relay (IPDM E/R) • Ignition relay (fuse block) • ACC relay • Blower relay
ECVT device	P range		
PNP switch	N, P range		
Stop lamp switch	Brake ON/OFF		

SYSTEM DESCRIPTION

- PDS (POWER DISTRIBUTION SYSTEM) is the system that BCM controls with the operation of the push-button ignition switch and performs the power distribution to each power circuit. This system is used instead of the mechanical power supply changing mechanism with the operation of the conventional key cylinder.
- The push-button ignition switch can be operated when Intelligent Key is in the following condition. Refer to Hybrid System Start Function for details.
 - Intelligent Key is in the detection area of the interior antenna
 - Insert Intelligent Key in to the key slot
- The push-button ignition switch operation is input to BCM as a signal. BCM changes the power supply position according to the status and operates the following relays to supply power to each power circuit.
 - Ignition relay-1 (inside IPDM E/R)
 - Ignition relay-2 [inside fuse block (J/B)]
 - ACC relay
 - Blower fan relay

NOTE:

The hybrid system switch operation changes due to the conditions of brake pedal, ECVT selector lever and vehicle speed.

- The power supply position can be confirmed with the lighting of the indicators near the push-button ignition switch.

PUSH-BUTTON IGNITION SWITCH OPERATION PROCEDURE

The power supply position changing operation can be performed with the following operation.

NOTE:

- When an Intelligent Key is within the detection area of inside key antenna and when it is inserted in to the key slot, it is equivalent to the operations below.
- When starting the hybrid system, the BCM monitors under the hybrid system start conditions,
 - Brake pedal operating condition
 - ECVT selector lever position
 - Vehicle speed
- Unless each start condition is fulfilled, the hybrid system will not respond regardless of how many times the push-button ignition switch is pressed. At that time, illumination repeats the position in the order of LOCK→ACC→ON→OFF.

Power supply position	Hybrid System start/stop condition		Push-button ignition switch operation frequency
	Brake pedal	ECVT selector lever position	
LOCK→ACC	Not depressed	Any position	1
LOCK→ACC→ON	Not depressed	Any position	2
LOCK→ACC→ON→OFF	Not depressed	Any position	3
LOCK→START ACC→START ON→START (Hybrid system start)	Depressed	P or N position (*1)	1 [If the switch is pressed once, the hybrid system starts from any power supply position (LOCK, ACC, and ON)]

POWER DISTRIBUTION SYSTEM

< FUNCTION DIAGNOSIS >

[POWER DISTRIBUTION SYSTEM]

Power supply position	Hybrid System start/stop condition		Push-button ignition switch operation frequency
	Brake pedal	ECVT selector lever position	
Hybrid system is running→OFF (Hybrid system stop)	—	Any position	1
Hybrid System is running→ACC (Hybrid System stop)	—	Any position other than P (*2)	1
Hybrid System stall return operation while driving	—	N position	1

*1: When the ECVT selector lever position is N position, the hybrid system start condition is different according to the vehicle speed.

- At vehicle speed of 4 km/h or less, the hybrid system can start only when the brake pedal is depressed.
- At vehicle speed of 4 km/h or more, the hybrid system can start even if the brake pedal is not depressed. (It is the same as "Hybrid System stall return operation while driving".)

*2: When the ECVT selector lever position is in any position other than P position and when the vehicle speed is 5 km/h or more, the hybrid system stop condition is different.

- Press and hold the push-button ignition switch for 2 seconds or more. (When the push-button ignition switch is pressed for too short a time, the operation may be invalid, so properly press and hold to prevent the incorrect operation.)
- Press the push-button ignition switch 3 times or more within 1.5 seconds. (Emergency stop operation)

Component Parts Location

INFOID:000000003071978

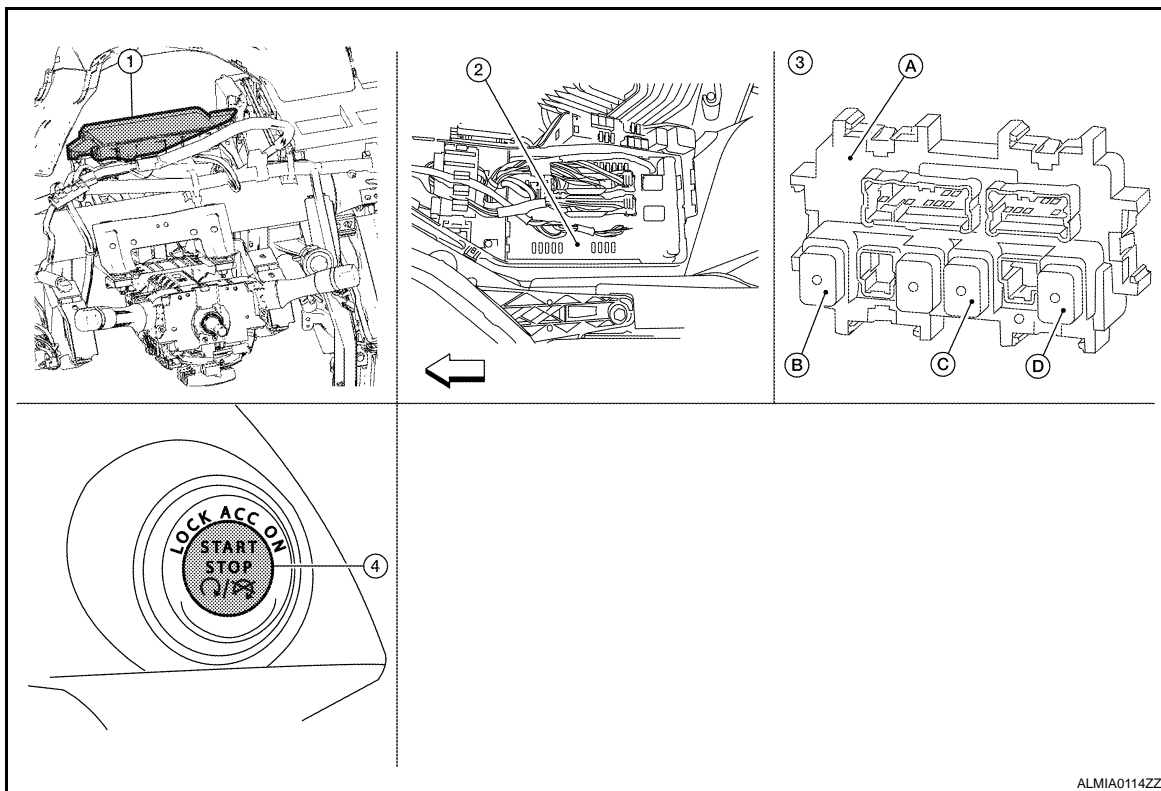

←: Vehicle front

- | | | |
|--|--|---|
| <p>1. BCM M16, M17, M18, M19, M21 (view with instrument panel removed)</p> <p>4. Push-button ignition switch M38</p> | <p>2. IPDM E/R E16, E17, E18 (contains Ignition relay-1)</p> | <p>3. A. Fuse block (J/B) M3, M4, M5, E6
B. Ignition relay-2
C. Accessory relay
D. Blower relay</p> |
|--|--|---|

POWER DISTRIBUTION SYSTEM

< FUNCTION DIAGNOSIS >

[POWER DISTRIBUTION SYSTEM]

Component Description

INFOID:000000003071979

BCM	Reference
IPDM E/R	PCS-3
Ignition relay-1 (In IPDM E/R)	PCS-61
Ignition relay-2 [In fuse block (J/B)]	PCS-58
Accessory relay	PCS-50
Blower relay	PCS-55
Stop lamp	SEC-40
Park/neutral position switch	SEC-54
Push-button ignition switch	SEC-81

DIAGNOSIS SYSTEM (BCM)

< FUNCTION DIAGNOSIS >

[POWER DISTRIBUTION SYSTEM]

DIAGNOSIS SYSTEM (BCM)

COMMON ITEM

COMMON ITEM : Diagnosis Description

INFOID:000000003301826

BCM CONSULT-III FUNCTION

CONSULT-III performs the following functions via CAN communication with BCM.

Diagnosis mode	Function Description
WORK SUPPORT	Changes the setting for each system function.
SELF-DIAG RESULTS	Displays the diagnosis results judged by BCM.
CAN DIAG SUPPORT MNTR	Monitors the reception status of CAN communication viewed from BCM.
DATA MONITOR	The BCM input/output signals are displayed.
ACTIVE TEST	The signals used to activate each device are forcibly supplied from BCM.
ECU IDENTIFICATION	The BCM part number is displayed.
CONFIGURATION	This function is not used even though it is displayed.

SYSTEM APPLICATION

BCM can perform the following functions for each system.

NOTE:

It can perform the diagnosis modes except the following for all sub system selection items.

System	Sub system selection item	Diagnosis mode		
		WORK SUPPORT	DATA MONITOR	ACTIVE TEST
Door lock	DOOR LOCK	×	×	×
Rear window defogger	REAR DEFOGGER		×	×
Warning chime	BUZZER		×	×
Interior room lamp timer	INT LAMP	×	×	×
Exterior lamp	HEAD LAMP	×	×	×
Wiper and washer	WIPER	×	×	×
Turn signal and hazard warning lamps	FLASHER	×	×	×
Air conditioner	AIR CONDITONER		×	
Intelligent Key system	INTELLIGENT KEY	×	×	×
Combination switch	COMB SW		×	
BCM	BCM	×		
Immobilizer	IMMU		×	×
Interior room lamp battery saver	BATTERY SAVER	×	×	×
Trunk open	TRUNK		×	
Vehicle security system	THEFT ALM	×	×	×
RAP system	RETAINED PWR		×	
Signal buffer system	SIGNAL BUFFER		×	×
TPMS	AIR PRESSURE MONITOR	×	×	×

COMMON ITEM : CONSULT-III Function

INFOID:000000003301827

ECU IDENTIFICATION

Displays the BCM part No.

SELF-DIAG RESULT

Refer to [PCS-105, "DTC Index"](#).

INTELLIGENT KEY

DIAGNOSIS SYSTEM (BCM)

< FUNCTION DIAGNOSIS >

[POWER DISTRIBUTION SYSTEM]

INTELLIGENT KEY : CONSULT-III Function (BCM - INTELLIGENT KEY) INFOID:00000003301829

BCM CONSULT-III FUNCTION

CONSULT-III performs the following functions via CAN communication with BCM.

Diagnosis mode	Function Description
WORK SUPPORT	Changes the setting for each system function.
SELF-DIAG RESULTS	Displays the diagnosis results judged by BCM.
DATA MONITOR	The BCM input/output signals are displayed.
ACTIVE TEST	The signals used to activate each device are forcibly supplied from BCM.

WORK SUPPORT

Monitor item	Description
REMO CONT ID CONFIR	It can be checked whether Intelligent Key ID code is registered or not in this mode.
LOCK/UNLOCK BY I-KEY	Door lock/unlock function by door request switch (driver side, passenger side and trunk) mode can be changed to operate (ON) or not operate (OFF) in this mode.
ENGINE START BY I-KEY	Engine start function mode can be changed to operate (ON) or not operate (OFF) with this mode.
TRUNK/GLASS HATCH OPEN	Buzzer reminder function mode by trunk opener request switch can be changed to operate (ON) or not operate (OFF) with this mode.
PANIC ALARM SET	Panic alarm button pressing time on Intelligent Key remote control button can be selected from the following with this mode. <ul style="list-style-type: none">• 0.5 sec.• 1.5 sec.• OFF: Non-operation
PW DOWN SET	Unlock button pressing time on Intelligent Key button can be selected from the following with this mode. <ul style="list-style-type: none">• 3 sec.• 5 sec.• OFF: Non-operation
TRUNK OPEN DELAY	Trunk button pressing time on Intelligent Key button can be selected from the following with this mode. <ul style="list-style-type: none">• 0.5 sec.• 1.5 sec.• OFF: Non-operation
LO- BATT OF KEY FOB WARN	Intelligent Key low battery warning mode can be changed to operate (ON) or not operate (OFF) with this mode.
ANTI KEY LOCK IN FUNCTI	Key reminder function mode can be changed to operate (ON) or not operate (OFF) with this mode.
HORN WITH KEYLESS LOCK	Horn reminder function mode by Intelligent Key button can be changed to operate (ON) or not operate (OFF) with this mode.
HAZARD ANSWER BACK	Hazard reminder function mode can be selected from the following with this mode. <ul style="list-style-type: none">• LOCK ONLY: Door lock operation only• UNLOCK ONLY: Door unlock operation only• LOCK AND UNLOCK: Lock/unlock operation• OFF: Non operation
ANS BACK I-KEY LOCK	Buzzer reminder function (lock operation) mode by door request switch (driver side and passenger side) can be selected from the following with this mode. <ul style="list-style-type: none">• HORN CHIRP: Sound horn• BUZZER: Sound Intelligent Key warning buzzer• OFF: Non-operation
ANS BACK I-KEY UNLOCK	Buzzer reminder function (unlock operation) mode by door request switch can be changed to operate (ON) or not operate (OFF) with this mode.

DIAGNOSIS SYSTEM (BCM)

< FUNCTION DIAGNOSIS >

[POWER DISTRIBUTION SYSTEM]

Monitor item	Description
SHORT CRANKING OUTPUT	Starter motor can operate during the times below. <ul style="list-style-type: none"> • 70 msec • 100 msec • 200 msec
INSIDE ANT DIAGNOSIS	This function allows inside key antenna self-diagnosis.

SELF-DIAG RESULT

Refer to [PCS-105, "DTC Index"](#).

DATA MONITOR

Monitor Item	Condition
REQ SW-DR	Indicates [ON/OFF] condition of door request switch (driver side).
REQ SW-AS	Indicates [ON/OFF] condition of door request switch (passenger side).
REQ SW-BD/TR	Indicates [ON/OFF] condition of trunk opener request switch.
PUSH SW	Indicates [ON/OFF] condition of push-button ignition switch.
BRAKE SW 1	Indicates [ON/OFF] condition of brake switch.
DETE/CANCL SW	Indicates [ON/OFF] condition of P position.
SFT P/N SW	Indicates [ON/OFF] condition of P or N position.
S/L -LOCK	Indicates [ON/OFF] condition of steering lock (LOCK).
S/L -UNLOCK	Indicates [ON/OFF] condition of steering lock (UNLOCK).
S/L RELAY-F/B	Indicates [ON/OFF] condition of ignition switch.
UNLK SEN-DR	Indicates [ON/OFF] condition of driver door UNLOCK status.
PUSH SW -IPDM	Indicates [ON/OFF] condition of push-button ignition switch.
IGN RLY1 F/B	Indicates [ON/OFF] condition of ignition relay 1.
DETE SW -IPDM	Indicates [ON/OFF] condition of P position.
SFT PN -IPDM	Indicates [ON/OFF] condition of P or N position.
SFT P -MET	Indicates [ON/OFF] condition of P position.
SFT N -MET	Indicates [ON/OFF] condition of N position.
ENGINE STATE	Indicates [STOP/START/CRANK/RUN] condition of engine states.
S/L LOCK-IPDM	Indicates [ON/OFF] condition of steering lock (LOCK).
S/L UNLOCK-IPDM	Indicates [ON/OFF] condition of steering lock (UNLOCK).
S/L RELAY-REQ	Indicates [ON/OFF] condition of steering lock relay.
VEH SPEED 1	Display the vehicle speed signal received from combination meter by numerical value [Km/h].
VEH SPEED 2	Display the vehicle speed signal received from ABS or eCVT by numerical value [Km/h].
DOOR STAT-DR	Indicates [LOCK/READY/UNLK] condition of driver side door status.
DOOR STAT-AS	Indicates [LOCK/READY/UNLK] condition of passenger side door status.
KEY SW -SLOT	Indicates [ON/OFF] condition of key slot.
RKE OPE COUN1	When remote keyless entry receiver receives the signal transmitted while operating on Intelligent Key, the numerical value start changing.
RKE OPE COUN2	NOTE: This item is displayed, but cannot be monitored.
TRNK/HAT MNTR	Indicates [ON/OFF] condition of trunk lid.
RKE-LOCK	Indicates [ON/OFF] condition of LOCK signal from Intelligent Key.
RKE-UNLOCK	Indicates [ON/OFF] condition of UNLOCK signal from Intelligent Key.
RKE-TR/BD	Indicates [ON/OFF] condition of TRUNK OPEN signal from Intelligent Key.
RKE-PANIC	Indicates [ON/OFF] condition of PANIC button of Intelligent Key.

A

B

C

D

E

F

G

H

I

J

K

L

PCS

N

O

P

DIAGNOSIS SYSTEM (BCM)

< FUNCTION DIAGNOSIS >

[POWER DISTRIBUTION SYSTEM]

Monitor Item	Condition
RKE-P/W OPEN	Indicates [ON/OFF] condition of P/W DOWN signal from Intelligent Key.
RKE-MODE CHG	Indicates [ON/OFF] condition of MODE CHANGE signal from Intelligent Key.

ACTIVE TEST

Test item	Description
BATTERY SAVER	This test is able to check interior room lamp operation. The interior room lamp will be activated after "ON" on CONSULT-III screen is touched.
PW REMOTO DOWN SET	This test is able to check power window down operation. The power window down will be activated after "ON" on CONSULT-III screen is touched.
OUTSIDE BUZZER	This test is able to check Intelligent Key warning buzzer operation. Intelligent Key warning buzzer sounds when "ON" on CONSULT-III screen is touched.
INSIDE BUZZER	This test is able to check warning chime in combination meter operation. <ul style="list-style-type: none"> • Take away warning chime sounds when "TAKE OUT" on CONSULT-III screen is touched. • Key warning chime sounds when "KEY WARN" on CONSULT-III screen is touched. • P position warning chime sounds when "P RNG WARN" on CONSULT-III screen is touched. • ACC warning chime sounds when "ACC WARN" on CONSULT-III screen is touched.
INDICATOR	This test is able to check warning lamp operation. <ul style="list-style-type: none"> • "KEY" Warning lamp illuminates when "KEY IND ON" on CONSULT-III screen is touched. • "KEY" Warning lamp flashes when "KEY IND FSH" on CONSULT-III screen is touched.
INT LAMP	This test is able to check interior room lamp operation. The interior room lamp will be activated after "ON" on CONSULT-III screen is touched.
LCD	This test is able to check meter display information <ul style="list-style-type: none"> • Engine start information displays when "BRAKE/P" on CONSULT-III screen is touched. • Engine start information displays when "BRAKE/P/ON" on CONSULT-III screen is touched. • Key ID warning displays when "KEY ID NG" on CONSULT-III screen is touched. • Steering lock information displays when "STLCK RELES" on CONSULT-III screen is touched. • P position warning displays when "P RNG IND" on CONSULT-III screen is touched. • Intelligent Key insert information displays when "INSERT KEY" on CONSULT-III screen is touched. • Intelligent Key low battery warning displays when "KEY BAT LOW" on CONSULT-III screen is touched. • Take away through window warning displays when "TK AWAY WDW" on CONSULT-III screen is touched. • Take away warning display when "TAKE AWAY" on CONSULT-III screen is touched. • OFF position warning display when "IGN OFF WARN" on CONSULT-III screen is touched.
TRUNK/GLASS HATCH	This test is able to check trunk lid opener actuator open operation. This actuator opens when "ON" on CONSULT-III screen is touched.
FLASHER	This test is able to check security hazard lamp operation. The hazard lamps will be activated after "ON" on CONSULT-III screen is touched.
HORN	This test is able to check horn operation. The horn will be activated after "ON" on CONSULT-III screen is touched.
IGN CONT2	This test is able to check security hazard lamp operation. The hazard lamps will be activated after "ON" on CONSULT-III screen is touched.
P RANGE	This test is able to check A/T device power supply A/T device power is supplied when "ON" on CONSULT-III screen is touched.
ENGINE SW ILLUMI	This test is able to check push-button ignition switch illumination operation. Push-button ignition switch illumination illuminates when "ON" on CONSULT-III screen is touched.
LOCK INDCATOR	This test is able to check LOCK indicator in push-ignition switch operation. LOCK indicator in push-ignition switch illuminates when "ON" on CONSULT-III screen is touched.
ACC INDCATOR	This test is able to check ACC indicator in push-ignition switch operation. LOCK indicator in push-ignition switch illuminates when "ON" on CONSULT-III screen is touched.
IGNITION ON IND	This test is able to check INGITION ON indicator in push-ignition switch operation. LOCK indicator in push-ignition switch illuminates when "ON" on CONSULT-III screen is touched.
KEY SLOT ILLUMI	This test is able to check key slot illumination operation. Key slot illumination flash when "ON" on CONSULT-III screen is touched.

U1000 CAN COMM CIRCUIT

< COMPONENT DIAGNOSIS >

[POWER DISTRIBUTION SYSTEM]

COMPONENT DIAGNOSIS

U1000 CAN COMM CIRCUIT

Description

INFOID:000000003071983

Refer to [BCS-36, "Description"](#).

DTC Logic

INFOID:000000003071984

DTC DETECTION LOGIC

CONSULT-III display description	DTC Detection Condition	Possible cause
CAN COMM CIRCUIT [U1000]	When IPDM E/R cannot communicate CAN communication signal continuously for 2 seconds or more	In CAN communication system, any item (or items) of the following listed below is malfunctioning. <ul style="list-style-type: none">• ECTV• Receiving (ECM)• Receiving (VDC/TCS/ABS)• Receiving (METER/M&A)• Hybrid vehicle control ECU (HV ECU)• Receiving (BCM)

Diagnosis Procedure

INFOID:000000003071985

1. PERFORM SELF DIAGNOSTIC

1. Turn ignition switch ON and wait for 2 seconds or more.
2. Check "SELF-DIAG RESULTS".

Is "CAN COMM CIRCUIT" displayed?

- YES >> Refer to [LAN-8, "CAN Communication Control Circuit"](#).
NO >> Refer to [GI-42, "Intermittent Incident"](#).

A
B
C
D
E
F
G
H
I
J
K
L
N
O
P

PCS

U1010 CONTROL UNIT (CAN)

< COMPONENT DIAGNOSIS >

[POWER DISTRIBUTION SYSTEM]

U1010 CONTROL UNIT (CAN)

DTC Logic

INFOID:000000003071986

DTC DETECTION LOGIC

CONSULT-III display description	DTC Detection Condition	Possible cause
CAN COMM CIRCUIT [U1010]	BCM detected internal CAN communication circuit malfunction.	BCM

Diagnosis Procedure

INFOID:000000003071987

1. REPLACE BCM

When DTC U1010 is detected, replace BCM.

>> Replace BCM. Refer to [BCS-85, "Removal and Installation"](#).

B2553 IGNITION RELAY

< COMPONENT DIAGNOSIS >

[POWER DISTRIBUTION SYSTEM]

B2553 IGNITION RELAY

Description

INFOID:000000003071988

BCM turns ON the following relays to ignition power supply to each ECU when the ignition switch is turned ON.

- Ignition relay-1 (inside IPDM E/R)
- Ignition relay-2 [inside fuse block (J/B)]
- Blower relay

BCM checks any ignition relay ON request for consistency with the actual ignition relay operation status.

DTC Logic

INFOID:000000003071989

DTC DETECTION LOGIC

DTC No.	Trouble diagnosis name	DTC detecting condition	Possible cause
B2553	IGNITION RELAY	BCM detects a difference of signal for 2 seconds or more between the following information. <ul style="list-style-type: none"> • Ignition relay-2 (fuse block) ON/OFF operation • Ignition relay-2 (fuse block) feedback. 	<ul style="list-style-type: none"> • Harness or connectors (ignition relay-2 feedback circuit is open or short)

DTC CONFIRMATION PROCEDURE

1. PERFORM DTC CONFIRMATION PROCEDURE

1. Turn ignition switch ON under the following conditions, and wait for at least 2 seconds.
 - CVT selector lever is in the P or N position.
 - Release brake pedal.
2. Check "SELF-DIAG RESULTS" with CONSULT-III.

Is DTC detected?

- YES >> Refer to [PCS-47, "Diagnosis Procedure"](#).
 NO >> INSPECTION END

Diagnosis Procedure

INFOID:000000003071990

1. CHECK IGNITION RELAY FEEDBACK INPUT SIGNAL

Check voltage between BCM harness connector and ground under the following conditions.

Terminals		Condition	Voltage (V)
(+)	(-)		
BCM			
Connector	Terminal		
M18	31		

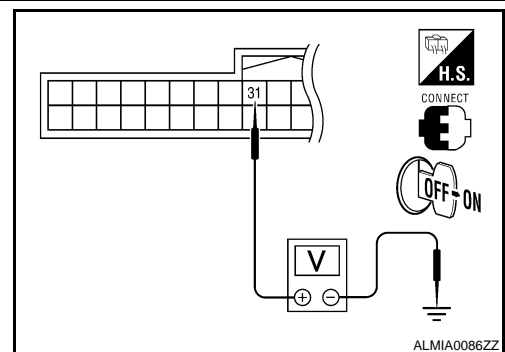

Is the inspection result normal?

- YES >> Replace BCM. Refer to [BCS-85, "Removal and Installation"](#).
 NO >> GO TO 2

2. CHECK IGNITION RELAY FEEDBACK CIRCUIT

B2553 IGNITION RELAY

[POWER DISTRIBUTION SYSTEM]

< COMPONENT DIAGNOSIS >

1. Turn ignition switch OFF.
2. Disconnect fuse block.
3. Check continuity between BCM harness connector and fuse block harness connector.

BCM		Fuse block		Continuity
Connector	Terminal	Connector	Terminal	
M18	31	M5	2N	Yes

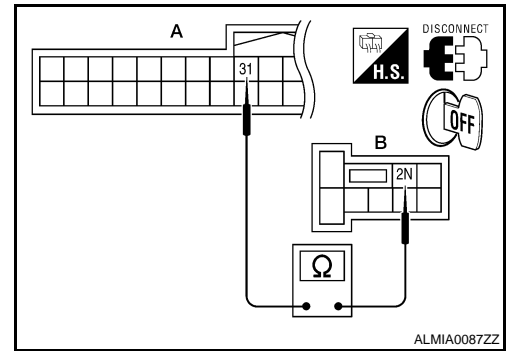

4. Check continuity between BCM harness connector and ground.

BCM		Ground	Continuity
Connector	Terminal		
M18	31		No

Is the inspection result normal?

- YES >> GO TO 3
 NO >> Repair or replace harness.

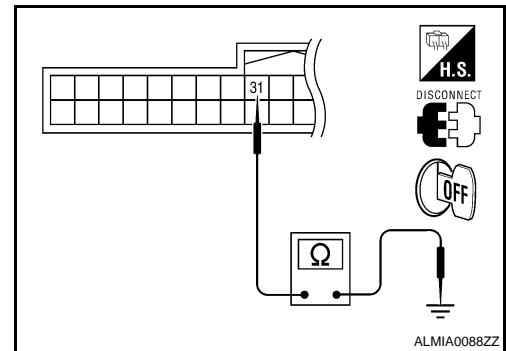

3. CHECK INTERMITTENT INCIDENT

Refer to [GI-42. "Intermittent Incident"](#).

>> INSPECTION END

B260A IGNITION RELAY

< COMPONENT DIAGNOSIS >

[POWER DISTRIBUTION SYSTEM]

B260A IGNITION RELAY

Description

INFOID:000000003071991

BCM turns ON the following relays to ignition power supply to each ECU when the ignition switch is turned ON.

- Ignition relay-1 (inside IPDM E/R)
- Ignition relay-2 [inside fuse block (J/B)]
- Front blower motor relay

BCM checks any ignition relay ON request for consistency with the actual ignition relay operation status.

DTC Logic

INFOID:000000003071992

DTC DETECTION LOGIC

NOTE:

- If DTC B260A is displayed with DTC U1000, first perform the trouble diagnosis for DTC U1000. Refer to [PCS-45, "DTC Logic"](#).
- If DTC B260A is displayed with DTC U1010, first perform the trouble diagnosis for DTC U1010. Refer to [PCS-46, "DTC Logic"](#).
- If DTC B260A is displayed with DTC B261A, first perform the trouble diagnosis for DTC B261A. Refer to [PCS-62, "DTC Logic"](#).

DTC No.	Trouble diagnosis name	DTC detecting condition	Possible cause
B260A	IGNITION RELAY	BCM detects a difference of signal for 2 second or more between the following information. <ul style="list-style-type: none">• Ignition relay-1 (ON/OFF) operation• Ignition relay-1 feedback	<ul style="list-style-type: none">• Harness or connectors (Ignition relay-1 operation circuit is open or shorted.)

DTC CONFIRMATION PROCEDURE

1. PERFORM DTC CONFIRMATION PROCEDURE

1. Turn ignition switch ON under the following conditions, and wait for at least 2 seconds.
 - CVT selector lever is in the P or N position.
 - Release the brake pedal.
2. Check "SELF-DIAG RESULTS" with CONSULT-III.

Is DTC detected?

- YES >> Refer to [PCS-49, "Diagnosis Procedure"](#).
NO >> INSPECTION END

Diagnosis Procedure

INFOID:000000003071993

1. CHECK DTC WITH IPDM E/R

Check "SELF-DIAG RESULTS" with CONSULT-III. Refer to [PCS-32, "DTC Index"](#).

Is DTC detected?

- YES >> Replace IPDM E/R. Refer to [PCS-34, "Removal and Installation"](#).
NO >> GO TO 2

2. CHECK INTERMITTENT INCIDENT

Refer to [GI-42, "Intermittent Incident"](#).

>> INSPECTION END

A
B
C
D
E
F
G
H
I
J
K
L
N
O
P

PCS

B2611 ACC RELAY

< COMPONENT DIAGNOSIS >

[POWER DISTRIBUTION SYSTEM]

B2611 ACC RELAY

Description

INFOID:000000003071994

BCM turns ON the ACC relay to supply ACC power to each ECU when the power supply position changes to ACC.

BCM check ACC relay ON request for consistency with the actual ACC relay operation status.

DTC Logic

INFOID:000000003071995

DTC DETECTION LOGIC

NOTE:

- If DTC B2611 is displayed with DTC U1000, first perform the trouble diagnosis for DTC U1000. Refer to [PCS-45, "DTC Logic"](#).
- If DTC B2611 is displayed with DTC U1010, first perform the trouble diagnosis for DTC U1010. Refer to [PCS-46, "DTC Logic"](#).

DTC No.	Trouble diagnosis name	DTC detecting condition	Possible cause
B2611	ACC RELAY	BCM detects a difference of signal for 2 seconds or more between the following information. <ul style="list-style-type: none"> • ACC relay ON/OFF operation • ACC relay feedback. 	<ul style="list-style-type: none"> • Harness or connectors (ACC relay feed back circuit is open or shorted)

DTC CONFIRMATION PROCEDURE

1. PERFORM DTC CONFIRMATION PROCEDURE

1. Turn the power supply position to ACC under the following conditions, and wait for at least 2 seconds.
 - CVT selector lever is in P or N position
 - Brake not depressed
2. Check "SELF-DIAG RESULTS" with CONSULT-III.

Is DTC detected?

- YES >> Refer to [PCS-50, "Diagnosis Procedure"](#).
NO >> INSPECTION END

Diagnosis Procedure

INFOID:000000003071996

1. CHECK ACC RELAY FEED BACK INPUT SIGNAL

Check voltage between BCM harness connector and ground under the following conditions.

Terminals		Condition	Voltage (V)
(+)	(-)		
BCM			
Connector	Terminal		
M18	30	Ignition switch OFF	Battery voltage
		ACC	

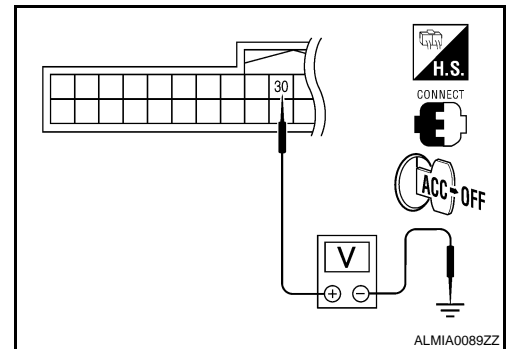

Is the inspection result normal?

- YES >> GO TO 5
NO >> GO TO 2

2. CHECK ACC RELAY POWER SUPPLY CIRCUIT

1. Turn ignition switch OFF.
2. Disconnect ACC relay.
3. Check voltage between ACC relay harness connector and ground.

B2611 ACC RELAY

< COMPONENT DIAGNOSIS >

[POWER DISTRIBUTION SYSTEM]

Terminals		Voltage (V)
(+)	(-)	
ACC relay	Ground	Battery voltage
Terminal		
5		

Is the inspection result normal?

YES >> GO TO 3

NO >> Repair or replace harness.

3. CHECK FUSE

Check 10A fuse [No. 19, located in the fuse block (J/B)].

Is the inspection result normal?

YES >> GO TO 4

NO >> Replace fuse.

4. CHECK ACC RELAY FEEDBACK CIRCUIT

1. Check continuity between ACC relay harness connector and BCM harness connector.

ACC relay	BCM		Continuity
Terminal	Connector	Terminal	
3	M18	30	Yes

2. Check continuity between ACC relay harness connector and ground.

ACC relay	Ground	Continuity
Terminal		
3		No

Is the inspection result normal?

YES >> GO TO 5

NO >> Repair or replace harness.

5. CHECK INTERMITTENT

Refer to [GI-42, "Intermittent Incident"](#).

>> INSPECTION END

PCS

B2614 ACC RELAY CIRCUIT

< COMPONENT DIAGNOSIS >

[POWER DISTRIBUTION SYSTEM]

B2614 ACC RELAY CIRCUIT

Description

INFOID:000000003071997

BCM controls the various electrical components and simultaneously supplies power according to the power supply position.
BCM checks the power supply position internally.

DTC Logic

INFOID:000000003071998

DTC DETECTION LOGIC

DTC No.	Trouble diagnosis name	DTC detecting condition	Possible cause
B2614	ACC relay circuit	An immediate operation of ACC relay is requested by BCM, but there is no response for more than 1 second.	<ul style="list-style-type: none"> Harness or connectors (ACC relay circuit is open or shorted) ACC relay

DTC CONFIRMATION PROCEDURE

1. PERFORM DTC CONFIRMATION PROCEDURE

- Turn the power supply position to ACC under the following conditions, and wait for at least 1 second.
 - CVT selector lever is in the P or N position.
 - Release the brake pedal.
- Check "SELF-DIAG RESULTS" with CONSULT-III.

Is DTC detected?

- YES >> Refer to [PCS-52, "Diagnosis Procedure"](#).
 NO >> INSPECTION END

Diagnosis Procedure

INFOID:000000003071999

1. CHECK ACCESSORY RELAY POWER SUPPLY

- Turn ignition switch OFF.
- Disconnect accessory relay.
- Check voltage between accessory relay harness connector and ground under the following conditions.

Terminals		Condition	Voltage (V)
(+)	(-)		
Accessory relay	Ground	Ignition	0
Terminal			OFF
1		ACC	

Is the inspection result normal?

- YES >> GO TO 3
 NO >> GO TO 2

2. CHECK ACCESSORY RELAY POWER SUPPLY CIRCUIT

- Turn ignition switch OFF.
- Disconnect BCM.
- Check continuity between accessory relay harness connector and BCM harness connector.

Accessory relay	BCM		Continuity
Terminal	Connector	Terminal	
1	M19	83	Yes

- Check continuity between accessory relay harness connector and ground.

B2614 ACC RELAY CIRCUIT

< COMPONENT DIAGNOSIS >

[POWER DISTRIBUTION SYSTEM]

Accessory relay	Ground	Continuity
Terminal		
1		No

Is the inspection result normal?

- YES >> GO TO 6
- NO >> Repair or replace harness.

3. CHECK ACCESSORY RELAY GROUND CIRCUIT

1. Turn ignition switch OFF.
2. Check continuity between accessory relay harness connector and ground.

Accessory relay	Ground	Continuity
Terminal		
2		Yes

Is the inspection result normal?

- YES >> GO TO 4
- NO >> Repair or replace harness.

4. CHECK ACCESSORY RELAY POWER SUPPLY CIRCUIT-2

Check voltage between accessory relay harness connector and ground.

Terminals		Voltage (V)
(+)	(-)	
Accessory relay	Ground	
Terminal		
5		Battery voltage

Is the inspection result normal?

- YES >> GO TO 5
- NO >> Repair or replace harness.

5. CHECK ACCESSORY RELAY

Refer to [PCS-53, "Component Inspection \(Accessory Relay\)"](#).

YES or NO

- YES >> GO TO 6
- NO >> Replace accessory relay.

6. CHECK INTERMITTENT INCIDENT

Refer to [GI-42, "Intermittent Incident"](#).

>> INSPECTION END

Component Inspection (Accessory Relay)

INFOID:000000003072000

1. CHECK ACCESSORY RELAY

A
B
C
D
E
F
G
H
I
J
K
L
N
O
P

B2614 ACC RELAY CIRCUIT

< COMPONENT DIAGNOSIS >

[POWER DISTRIBUTION SYSTEM]

1. Turn ignition switch OFF.
2. Remove accessory relay.
3. Check the continuity between accessory relay terminals under the following conditions.

Terminals	Condition	Continuity
3 and 5	12V direct current supply between terminals 1 and 2	Yes
	No current supply	No

Is the inspection result normal?

- YES >> INSPECTION END
NO >> Replace accessory relay.

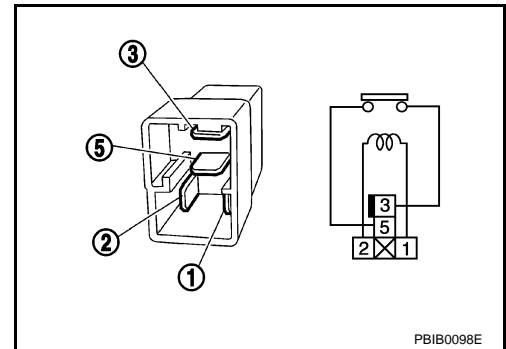

B2615 BLOWER RELAY CIRCUIT

< COMPONENT DIAGNOSIS >

[POWER DISTRIBUTION SYSTEM]

B2615 BLOWER RELAY CIRCUIT

Description

INFOID:000000003072001

BCM controls the various electrical components and simultaneously supplies power according to the power supply position.
BCM checks the power supply position internally.

DTC Logic

INFOID:000000003072002

DTC DETECTION LOGIC

DTC No.	Trouble diagnosis name	DTC detecting condition	Possible cause
B2615	Blower relay circuit	BCM detects a difference of signal for 1 second or more between the following information. <ul style="list-style-type: none">• Front blower motor relay ON/OFF request• Front blower motor relay feedback	<ul style="list-style-type: none">• Harness or connectors (Front blower motor relay circuit is open or shorted)• Front blower motor relay

DTC CONFIRMATION PROCEDURE

1. PERFORM DTC CONFIRMATION PROCEDURE

1. Turn ignition switch ON under the following conditions, and wait for at least 1 second.
 - CVT selector lever is in the P or N position.
 - Release brake pedal.
2. Check "SELF-DIAG RESULTS" with CONSULT-III.

Is DTC detected?

- YES >> Refer to [PCS-55, "Diagnosis Procedure"](#).
NO >> INSPECTION END

Diagnosis Procedure

INFOID:000000003072003

1. CHECK FRONT BLOWER MOTOR RELAY POWER SUPPLY

1. Turn ignition switch OFF.
2. Disconnect front blower motor relay.
3. Check voltage between front blower motor relay harness connector and ground under the following conditions.

Terminals		Condition	Voltage (V)
(+)	(-)		
Front blower motor relay	Ground	OFF or ACC	0
Terminal		ON	Battery voltage
1			

Is the inspection result normal?

- YES >> GO TO 3
NO >> GO TO 2

2. CHECK FRONT BLOWER MOTOR RELAY POWER SUPPLY CIRCUIT

1. Turn ignition switch OFF.
2. Disconnect BCM.
3. Check continuity between front blower motor relay harness connector and BCM harness connector.

Front blower motor relay	BCM		Continuity
	Connector	Terminal	
Terminal			
1	M19	90	Yes

B2615 BLOWER RELAY CIRCUIT

< COMPONENT DIAGNOSIS >

[POWER DISTRIBUTION SYSTEM]

4. Check continuity between front blower motor relay harness connector and ground.

Front blower motor relay	Ground	Continuity
Terminal		
1		No

Is the inspection result normal?

YES >> GO TO 6

NO >> Repair or replace harness.

3. CHECK FRONT BLOWER MOTOR RELAY GROUND CIRCUIT

1. Turn ignition switch OFF.
2. Check continuity between front blower motor relay harness connector and ground.

Front blower motor relay	Ground	Continuity
Terminal		
2		Yes

Is the inspection result normal?

YES >> GO TO 4

NO >> Repair or replace harness.

4. CHECK FRONT BLOWER MOTOR RELAY POWER SUPPLY CIRCUIT-2

Check voltage between front blower motor relay harness connector and ground.

Terminals		Voltage (V)
(+)	(-)	
Front blower motor relay	Ground	
Terminal		
5		Battery voltage

Is the inspection result normal?

YES >> GO TO 5

NO >> Repair or replace harness.

5. CHECK FRONT BLOWER MOTOR RELAY

Refer to [PCS-56. "Component Inspection \(Blower Relay\)"](#).

Is the inspection result normal?

YES >> GO TO 6

NO >> Replace front blower motor relay.

6. CHECK INTERMITTENT INCIDENT

Refer to [GI-42. "Intermittent Incident"](#).

>> INSPECTION END

Component Inspection (Blower Relay)

INFOID:000000003072004

1. CHECK FRONT BLOWER MOTOR RELAY

1. Turn ignition switch OFF.
2. Remove front blower motor relay.

B2615 BLOWER RELAY CIRCUIT

[POWER DISTRIBUTION SYSTEM]

< COMPONENT DIAGNOSIS >

3. Check the continuity between front blower motor relay terminals under the following conditions.

Terminals	Condition	Continuity
3 and 5	12V direct current supply between terminals 1 and 2	Yes
	No current supply	No

Is the inspection result normal?

YES >> INSPECTION END

NO >> Replace front blower motor relay.

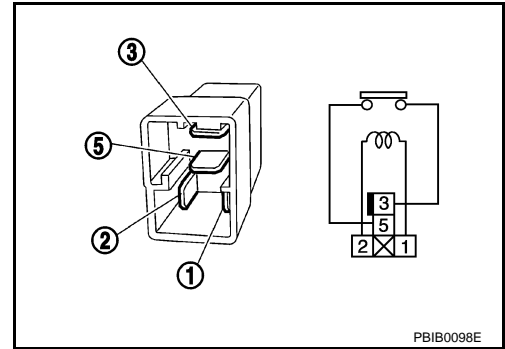

A
B
C
D
E
F
G
H
I
J
K
L
N
O
P

PCS

B2616 IGNITION RELAY CIRCUIT

< COMPONENT DIAGNOSIS >

[POWER DISTRIBUTION SYSTEM]

B2616 IGNITION RELAY CIRCUIT

Description

INFOID:000000003072005

BCM controls the various electrical components and simultaneously supplies power according to the power supply position.
BCM checks the power supply position internally.

DTC Logic

INFOID:000000003072006

DTC DETECTION LOGIC

DTC No.	Trouble diagnosis name	DTC detecting condition	Possible cause
B2616	Ignition relay circuit	An immediate operation of ignition relay-2 [fuse block (J/B)] is requested by BCM, but there is no response for more than 1 second	<ul style="list-style-type: none">• Harness or connectors (Ignition relay-2 circuit is open or shorted)• Ignition relay-2 [fuse block(J/B)]

DTC CONFIRMATION PROCEDURE

1. PERFORM DTC CONFIRMATION PROCEDURE

1. Turn ignition switch ON under the following conditions, and wait for at least 1 second.
 - CVT selector lever is in the P or N position
 - Release brake pedal
2. Check "SELF-DIAG RESULTS" with CONSULT-III.

Is DTC detected?

- YES >> Refer to [PCS-58, "Diagnosis Procedure"](#).
NO >> INSPECTION END

Diagnosis Procedure

INFOID:000000003072007

1. CHECK IGNITION RELAY-2 POWER SUPPLY

1. Turn ignition switch OFF.
2. Disconnect ignition relay-2.
3. Check voltage between ignition relay-2 harness connector and ground under the following conditions.

Terminals		Condition	Voltage (V)
(+)	(-)		
Ignition relay-2 Terminal	Ground	Ignition switch OFF or ACC	0
1		Ignition switch ON	Battery voltage

Is the inspection result normal?

- YES >> GO TO 3
NO >> GO TO 2

2. CHECK IGNITION RELAY-2 POWER SUPPLY CIRCUIT

1. Turn ignition switch OFF.
2. Disconnect BCM.
3. Check continuity between ignition relay-2 harness connector and BCM harness connector.

Ignition relay-2 Terminal	BCM		Continuity
	Connector	Terminal	
1	M19	70	Yes

4. Check continuity between blower relay harness connector and ground.

B2616 IGNITION RELAY CIRCUIT

< COMPONENT DIAGNOSIS >

[POWER DISTRIBUTION SYSTEM]

Ignition relay-2	Ground	Continuity
Terminal		
1		No

Is the inspection result normal?

- YES >> GO TO 6
- NO >> Repair or replace harness.

3. CHECK BLOWER RELAY GROUND CIRCUIT

1. Turn ignition switch OFF.
2. Check continuity between blower relay harness connector and ground.

Ignition relay-2	Ground	Continuity
Terminal		
2		Yes

Is the inspection result normal?

- YES >> GO TO 4
- NO >> Repair or replace harness.

4. CHECK IGNITION RELAY-2 POWER SUPPLY CIRCUIT-2

Check voltage between ignition relay-2 harness connector and ground.

Terminals		Voltage (V)
(+)	(-)	
Ignition relay-2	Ground	
Terminal		
5		Battery voltage

Is the inspection result normal?

- YES >> GO TO 5
- NO >> Repair or replace harness.

5. CHECK IGNITION RELAY-2

Refer to [PCS-59, "Component Inspection \(Ignition Relay\)"](#).

Is the inspection result normal?

- YES >> GO TO 6
- NO >> Replace ignition relay-2.

6. CHECK INTERMITTENT INCIDENT

Refer to [GI-42, "Intermittent Incident"](#).

>> INSPECTION END

Component Inspection (Ignition Relay)

INFOID:000000003072008

1. CHECK IGNITION RELAY-2

1. Turn ignition switch OFF.
2. Remove ignition relay-2.

A
B
C
D
E
F
G
H
I
J
K
L
N
O
P

B2616 IGNITION RELAY CIRCUIT

[POWER DISTRIBUTION SYSTEM]

< COMPONENT DIAGNOSIS >

3. Check the continuity between ignition relay-2 terminals under the following conditions.

Terminals	Condition	Continuity
3 and 5	12V direct current supply between terminals 1 and 2	Yes
	No current supply	No

Is the inspection result normal?

- YES >> INSPECTION END
- NO >> Replace ignition relay-2.

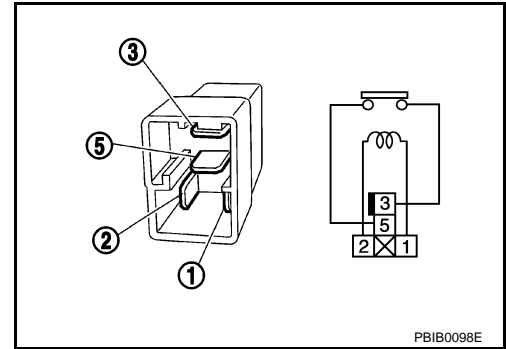

B2618 BCM

Description

INFOID:000000003072009

BCM controls the various electrical components and simultaneously supplies power according to the power supply position.
 BCM checks the power supply position internally.

DTC Logic

INFOID:000000003072010

DTC DETECTION LOGIC

NOTE:

- If DTC B2618 is displayed with DTC U1000, first perform the trouble diagnosis for DTC U1000. Refer to [PCS-45, "DTC Logic"](#).
- If DTC B2618 is displayed with DTC U1010, first perform the trouble diagnosis for DTC U1010. Refer to [PCS-46, "DTC Logic"](#).

DTC No.	Trouble diagnosis name	DTC detecting condition	Possible cause
B2618	BCM	An immediate operation of ignition relay (IPDM E/R) is requested by BCM, but there is no response for more than 1 second	<ul style="list-style-type: none"> • BCM

DTC CONFIRMATION PROCEDURE

1. PERFORM DTC CONFIRMATION PROCEDURE

1. Turn ignition switch ON under the following conditions, and wait for at least 1 second.
 - CVT selector lever is in the P or N position
 - Release brake pedal
2. Check "SELF-DIAG RESULTS" with CONSULT-III.

Is DTC detected?

- YES >> Refer to [PCS-61, "Diagnosis Procedure"](#).
- NO >> INSPECTION END

Diagnosis Procedure

INFOID:000000003072011

1. INSPECTION START

1. Turn ignition switch ON.
2. Select "SELF-DIAG RESULTS" mode with CONSULT-III.
3. Touch "ERASE".
4. **Perform DTC Confirmation Procedure.**
 See [PCS-61, "DTC Logic"](#).

Is the 1st trip DTC B2618 displayed again?

- YES >> Replace BCM. Refer to [BCS-85, "Removal and Installation"](#).
- NO >> INSPECTION END

A
B
C
D
E
F
G
H
I
J
K
L
N
O
P

PCS

B261A PUSH-BUTTON IGNITION SWITCH

< COMPONENT DIAGNOSIS >

[POWER DISTRIBUTION SYSTEM]

B261A PUSH-BUTTON IGNITION SWITCH

Description

INFOID:000000003072012

BCM transmits the change in the power supply position with the push-button ignition switch to IPDM E/R via the CAN communication line. IPDM E/R transmits the power supply position status via CAN communication line to BCM.

DTC Logic

INFOID:000000003072013

DTC DETECTION LOGIC

DTC No.	Trouble diagnosis name	DTC detecting condition	Possible cause
B261A	PUSH-BUTTON IGNITION SWITCH	BCM detects a difference of signal for 1 second or more between the following information. <ul style="list-style-type: none">Power supply position by push-button ignition switchPower supply position from IPDM E/R (CAN)	<ul style="list-style-type: none">Harness or connectors (Push-button ignition switch circuit is open or shorted.)

DTC CONFIRMATION PROCEDURE

1. PERFORM DTC CONFIRMATION PROCEDURE

- Press the push-button ignition switch under the following conditions, and wait for at least 1 second.
 - CVT selector lever is in the P or N position.
 - Release the brake pedal.
- Check "SELF-DIAG RESULTS" with CONSULT-III.

Is DTC detected?

- YES >> Refer to [PCS-62, "Diagnosis Procedure"](#).
NO >> INSPECTION END

Diagnosis Procedure

INFOID:000000003072014

1. CHECK PUSH-BUTTON IGNITION SWITCH OPERATION

Press push-button ignition switch and check if it turns to ON.

Does ignition switch turn to ON?

- YES >> GO TO 2
NO >> GO TO 4

2. CHECK IGNITION SWITCH OUTPUT SIGNAL (IPDM E/R)

- Disconnect push-button ignition switch.
- Check voltage between IPDM E/R harness connector and ground.

Terminals		Voltage (V)
(+)	(-)	
IPDM E/R		Ground
Connector	Terminal	
E18	28	
		Battery voltage

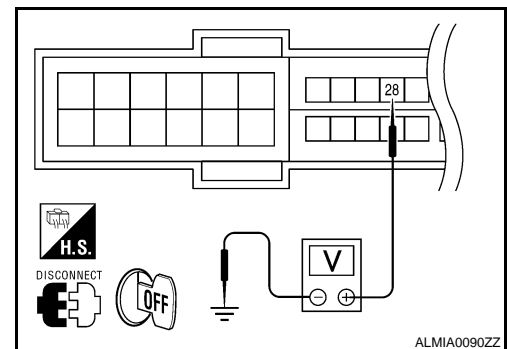

Is the inspection result normal?

- YES >> GO TO 3
NO >> Replace IPDM E/R. Refer to [PCS-34, "Removal and Installation"](#).

3. CHECK PUSH-BUTTON IGNITION SWITCH CIRCUIT (IPDM E/R)

B261A PUSH-BUTTON IGNITION SWITCH

[POWER DISTRIBUTION SYSTEM]

< COMPONENT DIAGNOSIS >

1. Disconnect IPDM E/R and BCM.
2. Check continuity between IPDM E/R harness connector (A) and push-button ignition switch harness connector (B).

IPDM E/R		Push-button ignition switch		Continuity
Connector	Terminal	Connector	Terminal	
E18 (A)	28	M38 (B)	4	Yes

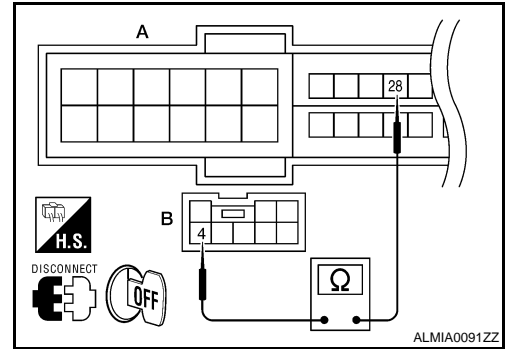

3. Check continuity between IPDM E/R harness connector and ground.

IPDM E/R		Ground	Continuity
Connector	Terminal		
E18	28		No

Is the inspection result normal?

YES >> GO TO 6

NO >> Repair or replace harness.

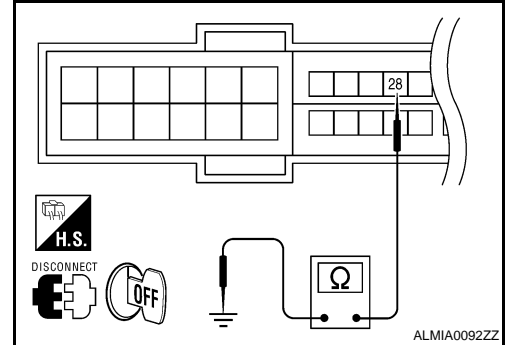

4. CHECK IGNITION SWITCH OUTPUT SIGNAL (BCM)

1. Disconnect push-button ignition switch.
2. Check voltage between BCM harness connector and ground.

Terminals		Voltage (V)
(+)	(-)	
BCM		Ground
Connector	Terminal	
M19	77	Battery voltage

Is the inspection result normal?

YES >> GO TO 5

NO >> Replace BCM. Refer to [PCS-124. "Removal and Installation"](#).

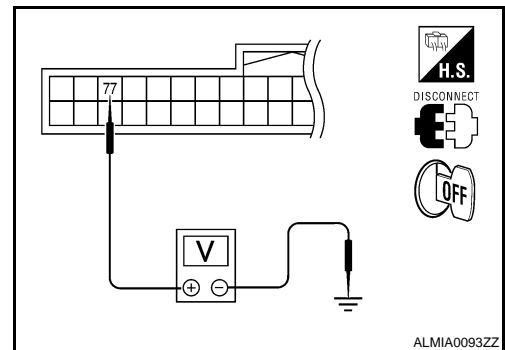

5. CHECK PUSH-BUTTON IGNITION SWITCH CIRCUIT (BCM)

1. Disconnect BCM and IPDM E/R.
2. Check continuity between BCM harness connector (A) and push-button ignition switch harness connector (B).

BCM		Push-button ignition switch		Continuity
Connector	Terminal	Connector	Terminal	
M19 (A)	77	M38 (B)	4	Yes

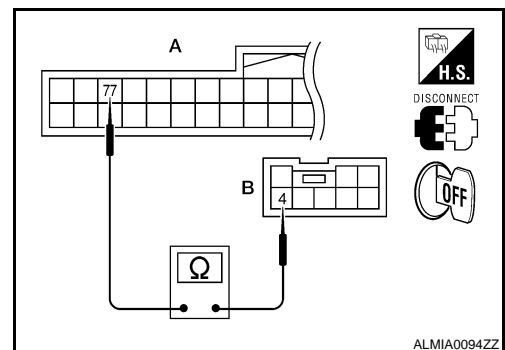

A
B
C
D
E
F
G
H
I
J
K
L
PCS
N
O
P

B261A PUSH-BUTTON IGNITION SWITCH

< COMPONENT DIAGNOSIS >

[POWER DISTRIBUTION SYSTEM]

3. Check continuity between BCM harness connector and ground.

BCM		Ground	Continuity
Connector	Terminal		
M19	77		No

Is the inspection result normal?

YES >> GO TO 6

NO >> Repair or replace harness.

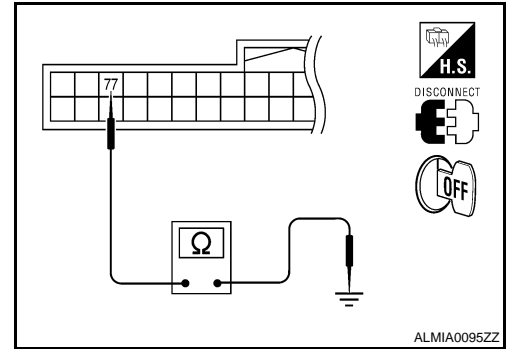

6. CHECK INTERMITTENT INCIDENT

Refer to [GI-42, "Intermittent Incident"](#).

>> INSPECTION END

POWER SUPPLY AND GROUND CIRCUIT

< COMPONENT DIAGNOSIS >

[POWER DISTRIBUTION SYSTEM]

POWER SUPPLY AND GROUND CIRCUIT

BCM

BCM : Diagnosis Procedure

INFOID:000000003301833

1. CHECK FUSE AND FUSIBLE LINK

Check if the following BCM fuse or fusible link are blown.

Terminal No.	Signal name	Fuse and fusible link No.
1	Battery power supply	J
11		10

Is the fuse or fusible link blown?

YES >> Replace the blown fuse or fusible link after repairing the affected circuit.

NO >> GO TO 2

2. CHECK POWER SUPPLY CIRCUIT

1. Turn ignition switch OFF.
2. Disconnect BCM.
3. Check voltage between BCM harness connector and ground.

Terminals		Voltage (Approx.)
(+)	(-)	
BCM		Ground
Connector	Terminal	
M16	1	
M17	11	
		Battery voltage

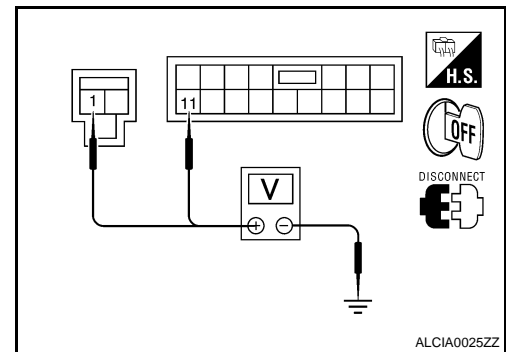

Is the measurement normal?

YES >> GO TO 3

NO >> Repair or replace harness.

3. CHECK GROUND CIRCUIT

Check continuity between BCM harness connector and ground.

BCM		Ground	Continuity
Connector	Terminal		
M17	13		Yes

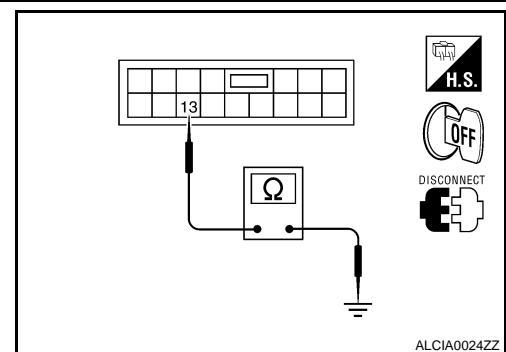

Does continuity exist?

YES >> Inspection End.

NO >> Repair or replace harness.

BCM : Special Repair Requirement

INFOID:000000003301834

1. REQUIRED WORK WHEN REPLACING BCM

Initialize control unit. Refer to CONSULT-III operation manual.

>> Work end.

IPDM E/R (INTELLIGENT POWER DISTRIBUTION MODULE ENGINE ROOM)

IPDM E/R (INTELLIGENT POWER DISTRIBUTION MODULE ENGINE ROOM) : Di-

A
B
C
D
E
F
G
H
I
J
K
L
PCS
N
O
P

POWER SUPPLY AND GROUND CIRCUIT

[POWER DISTRIBUTION SYSTEM]

< COMPONENT DIAGNOSIS >

INFOID:00000003301837

agnosis Procedure

1. CHECK FUSES AND FUSIBLE LINK

Check that the following IPDM E/R fuses or fusible link are not blown.

Terminal No.	Signal name	Fuses and fusible link No.
1, 2	Battery power supply	B, E, F
—		42
—		43

Is the fuse blown?

- YES >> Replace the blown fuse or fusible link after repairing the affected circuit.
 NO >> GO TO 2

2. CHECK POWER SUPPLY CIRCUIT

- Turn ignition switch OFF.
- Disconnect IPDM E/R.
- Check voltage between IPDM E/R harness connector and ground.

Terminals		Voltage (V) (Approx.)
(+)	(-)	
IPDM E/R		Ground
Connector	Terminal	
E16	1	
	2	
		Battery voltage

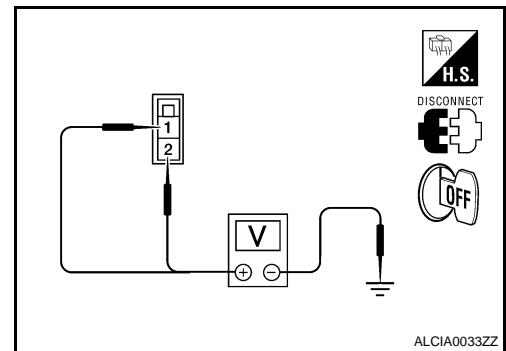

Is the measurement value normal?

- YES >> GO TO 3
 NO >> Repair or replace harness.

3. CHECK GROUND CIRCUIT

Check continuity between IPDM E/R harness connectors and ground.

IPDM E/R		Ground	Continuity
Connector	Terminal		
E18 (A)	12	Ground	Yes
E17 (B)	41		

Does continuity exist?

- YES >> Inspection End.
 NO >> Repair or replace harness.

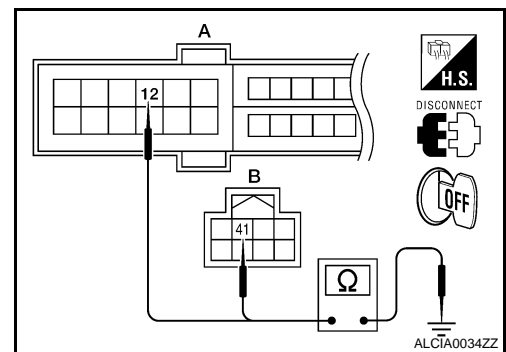

PUSH-BUTTON IGNITION SWITCH POSITION INDICATOR

< COMPONENT DIAGNOSIS >

[POWER DISTRIBUTION SYSTEM]

PUSH-BUTTON IGNITION SWITCH POSITION INDICATOR

Description

INFOID:000000003072018

The switch that changes the power supply position.

BCM maintains the power supply position status.

BCM changes the power supply position with the operation of the push-button ignition switch.

Component Function Check

INFOID:000000003072019

1. CHECK FUNCTION

With CONSULT-III

1. Check push-button ignition switch ("LOCK INDICATOR", "ACC INDICATOR" and "IGNITION ON IND") in Active Test Mode with CONSULT-III.

Test item		Description	
LOCK INDICATOR	ON	Position indicator	: Illuminate
ACC INDICATOR IGNITION ON IND	OFF		: Not illuminate

Is the inspection result normal?

YES >> INSPECTION END.

NO >> Refer to [PCS-67](#), "Diagnosis Procedure".

Diagnosis Procedure

INFOID:000000003072020

1. CHECK PUSH-BUTTON IGNITION SWITCH INPUT SIGNAL

1. Turn ignition switch OFF.
2. Disconnect push-button ignition switch.
3. Check voltage between push-button ignition switch harness connector and ground.

Terminals		Voltage (V)
(+)	(-)	
Push-button ignition switch		Battery voltage
Connector	Terminal	
E38	8	

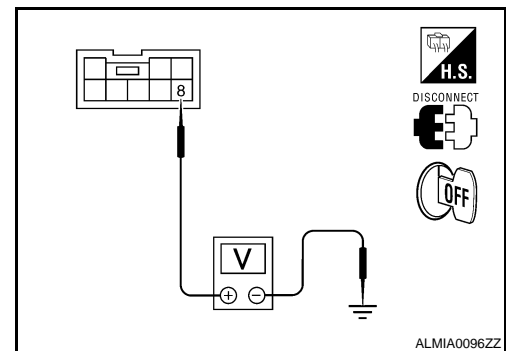

Is the inspection normal?

YES >> GO TO 2

NO >> Check the following.

- 10A fuse [No. 9, located in fuse block (J/B)]
- Harness for open or short between push-button ignition switch and fuse.

2. CHECK PUSH-BUTTON IGNITION SWITCH CIRCUIT

A
B
C
D
E
F
G
H
I
J
K
L
N
O
P

PUSH-BUTTON IGNITION SWITCH POSITION INDICATOR

[POWER DISTRIBUTION SYSTEM]

< COMPONENT DIAGNOSIS >

1. Disconnect BCM and push-button ignition switch.
2. Check continuity between BCM harness connector and push-button ignition switch harness connector.

Indicator	BCM Connector	Terminal	Push-button ignition switch connector	Terminal	Continuity
LOCK	M18 (A)	42	E38 (D)	5	Yes
ACC	M17 (B)	15		6	
ON	M19 (C)	81		7	

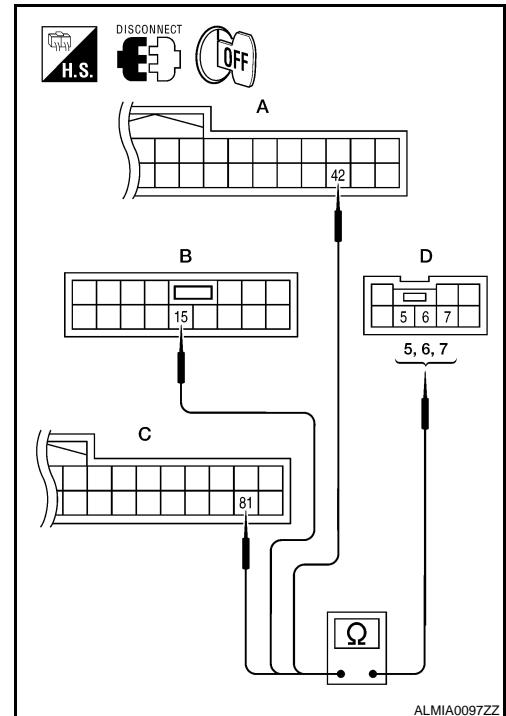

3. Check continuity between BCM harness connector and ground.

Indicator	BCM connector	Terminal	Ground	Continuity
LOCK	M18 (A)	42	Ground	No
ACC	M17 (B)	15		
ON	M19 (C)	81		

Is the inspection normal?

- YES >> GO TO 3
 NO >> Repair or replace harness.

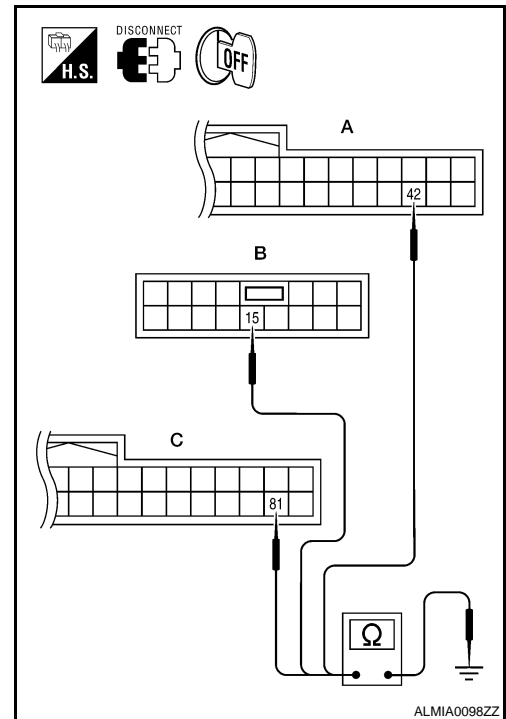

3. CHECK PUSH-BUTTON IGNITION SWITCH

Refer to [PCS-69, "Component Inspection"](#).

Is the inspection normal?

- YES >> GO TO 4
 NO >> Replace push-button ignition switch. Refer to [SEC-184, "Removal and Installation"](#).

4. CHECK INTERMITTENT INCIDENT

Refer to [GI-42, "Intermittent Incident"](#).

>> INSPECTION END

PUSH-BUTTON IGNITION SWITCH POSITION INDICATOR

< COMPONENT DIAGNOSIS >

[POWER DISTRIBUTION SYSTEM]

Component Inspection

INFOID:000000003072021

1. CHECK PUSH-BUTTON IGNITION SWITCH

Check push-button ignition switch.

Terminal		Push-button ignition switch position	Continuity
Push-button ignition switch			
8	5	LOCK	Yes
	6	ACC	
	7	ON	

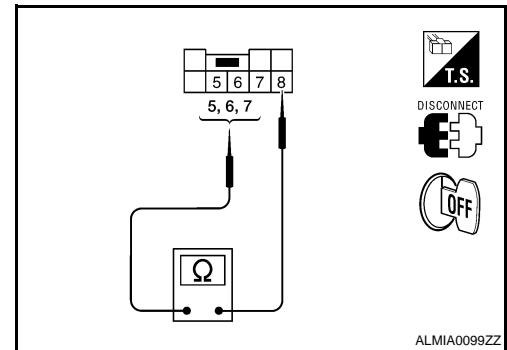

Is the inspection result normal?

YES >> INSPECTION END

NO >> Replace push-button ignition switch. Refer to [SEC-184](#), "[Removal and Installation](#)".

A
B
C
D
E
F
G
H
I
J
K
L
N
O
P

PCS

BCM (BODY CONTROL MODULE)

< ECU DIAGNOSIS >

[POWER DISTRIBUTION SYSTEM]

ECU DIAGNOSIS

BCM (BODY CONTROL MODULE)

Reference Value

INFOID:000000003301842

VALUES ON THE DIAGNOSIS TOOL

Monitor Item	Condition	Value/Status
FR WIPER HI	Other than front wiper switch HI	OFF
	Front wiper switch HI	ON
FR WIPER LOW	Other than front wiper switch LO	OFF
	Front wiper switch LO	ON
FR WASHER SW	Front washer switch OFF	OFF
	Front washer switch ON	ON
FR WIPER INT	Other than front wiper switch INT	OFF
	Front wiper switch INT	ON
FR WIPER STOP	Front wiper is not in STOP position	OFF
	Front wiper is in STOP position	ON
INT VOLUME	Wiper intermittent dial is in a dial position 1 - 7	Wiper intermittent dial position
TURN SIGNAL R	Other than turn signal switch RH	OFF
	Turn signal switch RH	ON
TURN SIGNAL L	Other than turn signal switch LH	OFF
	Turn signal switch LH	ON
TAIL LAMP SW	Other than lighting switch 1ST and 2ND	OFF
	Lighting switch 1ST or 2ND	ON
HI BEAM SW	Other than lighting switch HI	OFF
	Lighting switch HI	ON
HEAD LAMP SW 1	Other than lighting switch 2ND	OFF
	Lighting switch 2ND	ON
HEAD LAMP SW 2	Other than lighting switch 2ND	OFF
	Lighting switch 2ND	ON
PASSING SW	Other than lighting switch PASS	OFF
	Lighting switch PASS	ON
AUTO LIGHT SW	Other than lighting switch AUTO	OFF
	Lighting switch AUTO	ON
FR FOG SW	Front fog lamp switch OFF	OFF
	Front fog lamp switch ON	ON
DOOR SW-DR	Front door LH closed	OFF
	Front door LH opened	ON
DOOR SW-AS	Front door RH closed	OFF
	Front door RH opened	ON
DOOR SW-RR	Rear door RH closed	OFF
	Rear door RH opened	ON
DOOR SW-RL	Rear door LH closed	OFF
	Rear door LH opened	ON

BCM (BODY CONTROL MODULE)

< ECU DIAGNOSIS >

[POWER DISTRIBUTION SYSTEM]

Monitor Item	Condition	Value/Status	
DOOR SW-BK	NOTE: This item is displayed, but cannot be monitored.	OFF	A
CDL LOCK SW	Other than power door lock switch LOCK	OFF	B
	Door lock/unlock switch LOCK	ON	
CDL UNLOCK SW	Other than door lock/unlock switch UNLOCK	OFF	C
	Door lock/unlock switch UNLOCK	ON	
KEY CYL LK-SW	Other than front door LH key cylinder LOCK position	OFF	D
	Front door LH key cylinder LOCK position	ON	
KEY CYL UN-SW	Other than front door LH key cylinder UNLOCK position	OFF	D
	Front door LH key cylinder UNLOCK position	ON	
KEY CYL SW-TR	NOTE: This item is displayed, but cannot be monitored.	OFF	E
HAZARD SW	When hazard switch is not pressed	OFF	F
	When hazard switch is pressed	ON	
REAR DEF SW	When rear window defogger switch is pressed	ON	
FAN ON SIG	When AUTO switch or fan switch is pressed	ON	
AIR COND SW	When A/C switch is pressed	ON	G
TR CANCEL SW	Trunk lid opener cancel switch OFF	OFF	H
	Trunk lid opener cancel switch ON	ON	
TR/BD OPEN SW	Trunk lid opener switch OFF	OFF	I
	While the trunk lid opener switch is turned ON	ON	
TRNK/HAT MNTR	Trunk lid closed	OFF	I
	Trunk lid opened	ON	
RKE-LOCK	When LOCK button of Intelligent Key is not pressed	OFF	J
	When LOCK button of Intelligent Key is pressed	ON	
RKE-UNLOCK	When UNLOCK button of Intelligent Key is not pressed	OFF	K
	When UNLOCK button of Intelligent Key is pressed	ON	
RKE-TR/BD	When TRUNK OPEN button of Intelligent Key is not pressed	OFF	L
	When TRUNK OPEN button of Intelligent Key is pressed	ON	
RKE-PANIC	When PANIC button of Intelligent Key is not pressed	OFF	L
	When PANIC button of Intelligent Key is pressed	ON	
RKE-P/W OPEN	When UNLOCK button of Intelligent Key is not pressed and held	OFF	PCS
	When UNLOCK button of Intelligent Key is pressed and held	ON	
RKE-MODE CHG	When LOCK/UNLOCK button of Intelligent Key is not pressed and held simultaneously	OFF	N
	When LOCK/UNLOCK button of Intelligent Key is pressed and held simultaneously	ON	
OPTICAL (LIGHT) SEN- SOR	When outside of the vehicle is bright	Close to 5 V	O
	When outside of the vehicle is dark	Close to 0 V	
REQ SW-DR	When front door LH request switch is not pressed	OFF	P
	When front door LH request switch is pressed	ON	
REQ SW-AS	When front door RH request switch is not pressed	OFF	P
	When front door RH request switch is pressed	ON	
REQ SW-BD/TR	When trunk request switch is not pressed	OFF	P
	When trunk request switch is pressed	ON	

BCM (BODY CONTROL MODULE)

< ECU DIAGNOSIS >

[POWER DISTRIBUTION SYSTEM]

Monitor Item	Condition	Value/Status
PUSH SW	When push-button ignition switch is not pressed	OFF
	When push-button ignition switch is pressed	ON
IGN RLY -F/B	Ignition switch OFF or ACC	OFF
	Ignition switch ON	ON
ACC RLY -F/B	Ignition switch OFF	OFF
	Ignition switch ACC or ON	ON
BRAKE SW 1	When the brake pedal is not depressed	ON
	When the brake pedal is depressed	OFF
DETE/CANCL SW	When selector lever is in P position	OFF
	When selector lever is in any position other than P	ON
SFT PN/N SW	When selector lever is in any position other than P or N	OFF
	When selector lever is in P or N position	ON
S/L -LOCK	Electronic steering column lock LOCK status	OFF
	Electronic steering column lock UNLOCK status	ON
S/L -UNLOCK	Electronic steering column lock UNLOCK status	OFF
	Electronic steering column lock LOCK status	ON
S/L RELAY-F/B	Ignition switch OFF or ACC	OFF
	Ignition switch ON	ON
UNLK SEN-DR	Front door LH UNLOCK status	OFF
	Front door LH LOCK status	ON
PUSH SW -IPDM	When push-button ignition switch is not pressed (IPDM E/R sends via CAN)	OFF
	When push-button ignition switch is pressed (IPDM E/R sends via CAN)	ON
IGN RLY1 F/B	Ignition switch OFF or ACC	OFF
	Ignition switch ON	ON
DETE SW -IPDM	When selector lever is in P position (IPDM E/R sends via CAN)	OFF
	When selector lever is in any position other than P (IPDM E/R sends via CAN)	ON
SFT PN -IPDM	When selector lever is in any position other than P or N (IPDM E/R sends via CAN)	OFF
	When selector lever is in P or N position (IPDM E/R sends via CAN)	ON
SFT P -MET	When selector lever is in any position other than P (combination meter sends via CAN)	OFF
	When selector lever is in P position (combination meter sends via CAN)	ON
SFT N -MET	When selector lever is in any position other than N (combination meter sends via CAN)	OFF
	When selector lever is in N position (combination meter sends via CAN)	ON
ENGINE STATE	Engine stopped	STOP
	While the engine stalls	STALL
	At engine cranking	CRANK
	Engine running	RUN
S/L LOCK-IPDM	Electronic steering column lock LOCK status (IPDM E/R sends via CAN)	OFF
	Electronic steering column lock UNLOCK status (IPDM E/R sends via CAN)	ON

BCM (BODY CONTROL MODULE)

< ECU DIAGNOSIS >

[POWER DISTRIBUTION SYSTEM]

Monitor Item	Condition	Value/Status	
S/L UNLCK-IPDM	Electronic steering column lock UNLOCK status (IPDM E/R sends via CAN)	OFF	A
	Electronic steering column lock LOCK status (IPDM E/R sends via CAN)	ON	B
S/L RELAY-REQ	Ignition switch OFF or ACC	OFF	C
	Ignition switch ON	ON	
VEH SPEED 1	While driving	Equivalent to speedometer reading	D
VEH SPEED 2	While driving	Equivalent to speedometer reading	
DR DOOR STATE	Front door LH LOCK status	LOCK	E
	Wait with selective UNLOCK operation (5 seconds)	READY	
	Front door LH UNLOCK status	UNLK	
AS DOOR STATE	Front door RH LOCK status	LOCK	F
	Wait with selective UNLOCK operation (5 seconds)	READY	
	Front door RH UNLOCK status	UNLK	
ID OK FLAG	Ignition switch ACC or ON	RESET	G
	Ignition switch OFF	SET	
PRMT ENG STAT	When the hybrid system start is prohibited	RESET	H
	When the hybrid system start is permitted	SET	
PRMT RKE STAT	NOTE: This item is displayed, but cannot be monitored.	RESET	I
KEY SW -SLOT	When Intelligent Key is not inserted into key slot	OFF	J
	When Intelligent Key is inserted into key slot	ON	
RKE OPE COUN1	During the operation of Intelligent Key	Operation frequency of Intelligent Key	K
RKE OPE COUN2	NOTE: This item is displayed, but cannot be monitored.	Operation frequency of Intelligent Key	L
AIR PRESS FL	Ignition switch ON (only when the signal from the transmitter is received)	Air pressure of front LH tire	PCS
AIR PRESS FR	Ignition switch ON (only when the signal from the transmitter is received)	Air pressure of front RH tire	
AIR PRESS RR	Ignition switch ON (only when the signal from the transmitter is received)	Air pressure of rear RH tire	
AIR PRESS RL	Ignition switch ON (only when the signal from the transmitter is received)	Air pressure of rear LH tire	
ID REGST FL1	When ID of front LH tire transmitter is registered (refer to WT-6. "ID Registration Procedure")	DONE	N
	When ID of front LH tire transmitter is not registered (refer to WT-6. "ID Registration Procedure")	YET	
ID REGST FR1	When ID of front RH tire transmitter is registered (refer to WT-6. "ID Registration Procedure")	DONE	O
	When ID of front RH tire transmitter is not registered (refer to WT-6. "ID Registration Procedure")	YET	
ID REGST RR1	When ID of rear RH tire transmitter is registered (refer to WT-6. "ID Registration Procedure")	DONE	P
	When ID of rear RH tire transmitter is not registered (refer to WT-6. "ID Registration Procedure")	YET	
ID REGST RL1	When ID of rear LH tire transmitter is registered (refer to WT-6. "ID Registration Procedure")	DONE	
	When ID of rear LH tire transmitter is not registered (refer to WT-6. "ID Registration Procedure")	YET	

BCM (BODY CONTROL MODULE)

< ECU DIAGNOSIS >

[POWER DISTRIBUTION SYSTEM]

Monitor Item	Condition	Value/Status
WARNING LAMP	Tire pressure indicator OFF	OFF
	Tire pressure indicator ON	ON

Terminal Layout

INFOID:000000003301843

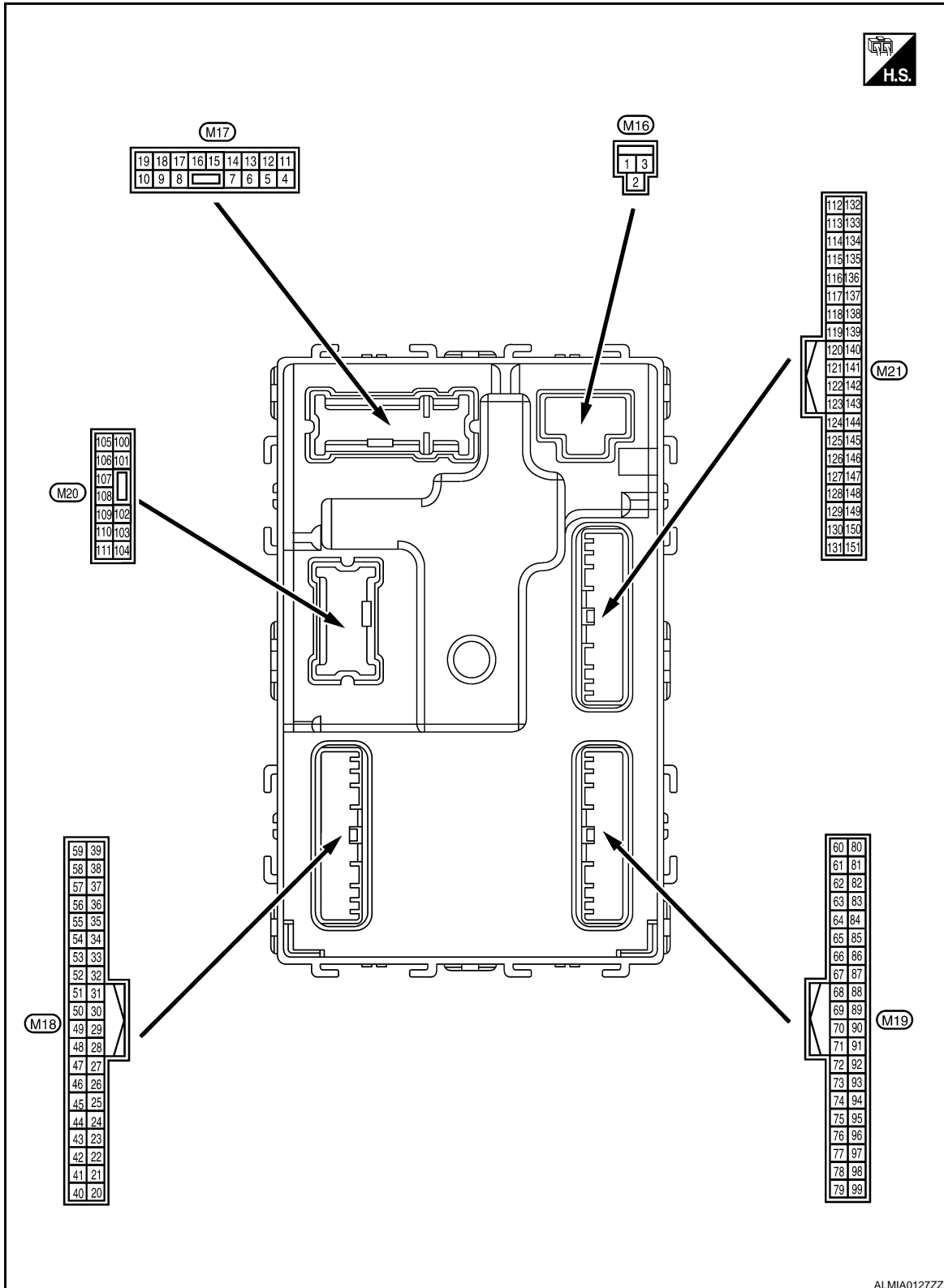

ALMIA0127ZZ

BCM (BODY CONTROL MODULE)

< ECU DIAGNOSIS >

[POWER DISTRIBUTION SYSTEM]

Physical Values

INFOID:000000003301844

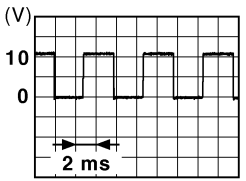
Terminal No. (Wire color)		Description		Condition		Value (Approx.)
		Signal name	Input/ Output			
(+)	(-)					
1 (W/B)	Ground	Battery power supply	Input	Ignition switch OFF		Battery voltage
2 (R/Y)	Ground	Battery power supply output	Output	Ignition switch OFF		Battery voltage
3 (L/W)	Ground	Ignition power supply output	Output	Ignition switch ON		Battery voltage
4 (P/W)	Ground	Interior room lamp power supply	Output	After passing the interior room lamp battery saver operation time		0V
				Any other time after passing the interior room lamp battery saver operation time		Battery voltage
5 (G/Y)	Ground	Front door RH UNLOCK	Output	Front door RH	UNLOCK (actuator is activated)	Battery voltage
					Other than UNLOCK (actuator is not activated)	0V
7 (R/W)	Ground	Step lamp	Output	Room lamp timer	ON	Battery voltage
					OFF	0V
8 (V)	Ground	All doors LOCK	Output	All doors	LOCK (actuator is activated)	Battery voltage
					Other than LOCK (actuator is not activated)	0V
9 (G)	Ground	Front door LH UNLOCK	Output	Front door LH	UNLOCK (actuator is activated)	Battery voltage
					Other than UNLOCK (actuator is not activated)	0V
10 (G/Y)	Ground	Rear door RH and rear door LH UNLOCK	Output	Rear door RH and rear door LH	UNLOCK (actuator is activated)	Battery voltage
					Other than UNLOCK (actuator is not activated)	0V
11 (Y/R)	Ground	Battery power supply	Input	Ignition switch OFF		Battery voltage
13 (B)	Ground	Ground	—	Ignition switch ON		0V
14 (R/Y)	Ground	Push-button ignition switch illumination ground	Input	Tail lamp	OFF	0V
					ON	<p>NOTE: When the illumination brightening/dimming level is in the neutral position</p>  <p style="text-align: right; font-size: small;">JSNIA0010GB</p>
15 (Y/L)	Ground	ACC indicator lamp	Output	Ignition switch	OFF	Battery voltage
					ACC	0V

A
B
C
D
E
F
G
H
I
J
K
L
N
O
P

PCS

BCM (BODY CONTROL MODULE)

< ECU DIAGNOSIS >

[POWER DISTRIBUTION SYSTEM]

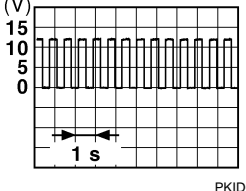
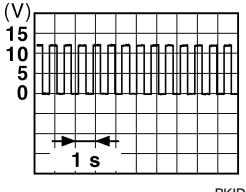
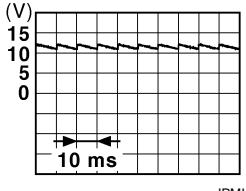
Terminal No. (Wire color)		Description		Condition		Value (Approx.)
(+)	(-)	Signal name	Input/ Output			
17 (G/B)	Ground	Turn signal (RH)	Output	Ignition switch ON	Turn signal switch OFF	0V
					Turn signal switch RH	
18 (G/O)	Ground	Turn signal (LH)	Output	Ignition switch ON	Turn signal switch OFF	0V
					Turn signal switch LH	
19 (Y)	Ground	Room lamp timer control	Output	Interior room lamp	Lamps fully OFF	Battery voltage
					Lamps fully ON	0V
21 (P/B)	Ground	Optical sensor signal	Input	Ignition switch ON	When outside of the vehi- cle is bright	Close to 5V
					When outside of the vehi- cle is dark	Close to 0V
24 (R/W)	Ground	Stop lamp switch 1	Input	—	Battery voltage	
26 (O/L)	Ground	Stop lamp switch 2	Input	Stop lamp switch	OFF (brake pedal is not de- pressed)	0V
					ON (brake pedal is de- pressed)	Battery voltage
				ICC brake hold relay (with ICC)	OFF	0V
					ON	Battery voltage
27 (G/W)	Ground	Front door lock as- sembly LH (unlock sensor)	Input	Front door LH	LOCK status	
					UNLOCK status	0V
29 (Y)	Ground	Key slot switch	Input	When Intelligent Key is inserted into key slot	Battery voltage	
				When Intelligent Key is not inserted into key slot	0V	
30 (V/Y)	Ground	ACC feedback signal	Input	Ignition switch	OFF	0
					ACC or ON	Battery voltage
31 (G)	Ground	Ignition relay-2 feed- back signal	Input	Ignition switch	OFF	0V
					ON	Battery voltage

BCM (BODY CONTROL MODULE)

[POWER DISTRIBUTION SYSTEM]

< ECU DIAGNOSIS >

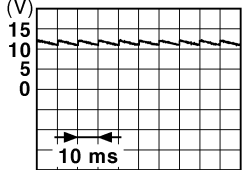
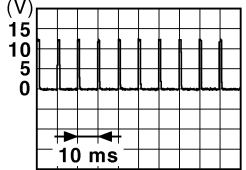
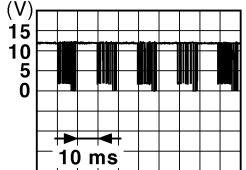
Terminal No. (Wire color)		Description		Condition	Value (Approx.)
		Signal name	Input/ Output		
(+)	(-)				
32 (R/B)	Ground	Front door RH switch	Input	Front door RH switch	<div style="display: flex; justify-content: space-between;"> <div>OFF (when front door RH closes)</div> <div style="text-align: right;">  <p style="text-align: right; font-size: small;">JPMIA0011GB</p> </div> </div>
				ON (when front door RH opens)	0V
33 (SB)	Ground	Compressor ON signal	Input	A/C switch	<div style="display: flex; justify-content: space-between;"> <div>OFF</div> <div style="text-align: right;">Battery voltage</div> </div> <div style="display: flex; justify-content: space-between;"> <div>ON</div> <div style="text-align: right;">0V</div> </div>
34* (L/R)	Ground	Front door lock assembly LH (key cylinder switch) (unlock)	Input	Front door lock assembly LH (key cylinder switch)	<div style="display: flex; justify-content: space-between;"> <div>OFF (neutral)</div> <div style="text-align: right;">Battery voltage</div> </div> <div style="display: flex; justify-content: space-between;"> <div>ON (unlock)</div> <div style="text-align: right;">0V</div> </div>
36* (GR)	Ground	Lock switch signal	Input	Door lock/unlock switch	<div style="display: flex; justify-content: space-between;"> <div>Lock</div> <div style="text-align: right;">Battery Voltage</div> </div> <div style="display: flex; justify-content: space-between;"> <div>Unlock</div> <div style="text-align: right;">0V</div> </div>
37 (O)	Ground	Trunk lid opener cancel switch	Input	Trunk lid opener cancel switch	<div style="display: flex; justify-content: space-between;"> <div>CANCEL</div> <div style="text-align: right;">  <p style="text-align: right; font-size: small;">JPMIA0012GB</p> </div> </div>
				ON	0V
38 (GR/W)	Ground	Rear window defogger ON signal	Input	Rear window defogger switch	<div style="display: flex; justify-content: space-between;"> <div>OFF</div> <div style="text-align: right;">Battery Voltage V</div> </div> <div style="display: flex; justify-content: space-between;"> <div>ON</div> <div style="text-align: right;">0V</div> </div>
39* (GR/R)	Ground	Unlock switch signal	Input	Door lock/unlock switch	<div style="display: flex; justify-content: space-between;"> <div>Unlock</div> <div style="text-align: right;">Battery Voltage</div> </div> <div style="display: flex; justify-content: space-between;"> <div>Lock</div> <div style="text-align: right;">0V</div> </div>
40* (Y/G)	Ground	Power window serial link	Input/ Output	Ignition switch ON	<div style="display: flex; justify-content: space-between;"> <div>  <p style="text-align: right; font-size: small;">JPMIA0013GB</p> </div> <div style="text-align: right;">10.2V</div> </div>
				Ignition switch OFF or ACC	0V
41 (W)	Ground	Push-button ignition switch illumination	Output	Engine switch (push switch) illumination	<div style="display: flex; justify-content: space-between;"> <div>ON</div> <div style="text-align: right;">5.5V</div> </div> <div style="display: flex; justify-content: space-between;"> <div>OFF</div> <div style="text-align: right;">0V</div> </div>
42 (R)	Ground	LOCK indicator lamp	Output	LOCK indicator lamp	<div style="display: flex; justify-content: space-between;"> <div>ON</div> <div style="text-align: right;">0V</div> </div> <div style="display: flex; justify-content: space-between;"> <div>OFF</div> <div style="text-align: right;">Battery voltage</div> </div>
45 (P)	Ground	Receiver & sensor ground	Input	Ignition switch ON	0V

A
B
C
D
E
F
G
H
I
J
K
L



PCS

N
O
P

BCM (BODY CONTROL MODULE)

[POWER DISTRIBUTION SYSTEM]

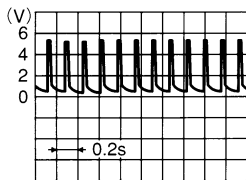
< ECU DIAGNOSIS >

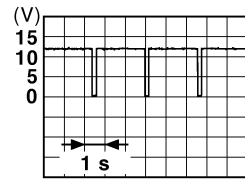
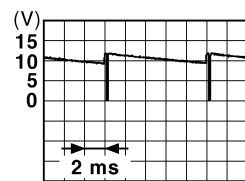
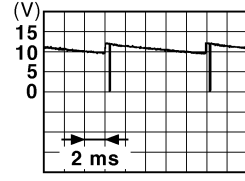
Terminal No. (Wire color)		Description		Condition	Value (Approx.)	
		Signal name	Input/ Output			
(+)	(-)					
46 (V/W)	Ground	Receiver & sensor power supply output	Output	Ignition switch	OFF	0V
					ACC or ON	5.0V
47 (G/O)	Ground	Tire pressure receiver signal	Input/ Output	Ignition switch ON	Standby state	
					When receiving the signal from the transmitter	
48 (R/B)	Ground	Selector lever P/N position signal	Input	Selector lever	P or N position	12.0V
					Except P and N positions	0V
49 (L/O)	Ground	Security indicator signal	Output	Security indicator	Blinking	
					OFF	Battery voltage
50 (LG/ B)	Ground	Combination switch OUTPUT 5	Output	Combination switch (Wiper intermittent dial 4)	All switch OFF	0V
					Lighting switch 1ST	
					Lighting switch high-beam	
					Lighting switch 2ND	
Turn signal switch RH	10.7V					
51 (L/W)	Ground	Combination switch OUTPUT 1	Output	Combination switch	All switch OFF (Wiper intermittent dial 4)	0V
					Front wiper switch HI (Wiper intermittent dial 4)	
		Any of the conditions below with all switch OFF	10.7V			
					<ul style="list-style-type: none"> • Wiper intermittent dial 1 • Wiper intermittent dial 2 • Wiper intermittent dial 3 • Wiper intermittent dial 6 • Wiper intermittent dial 7 	

BCM (BODY CONTROL MODULE)

[POWER DISTRIBUTION SYSTEM]

< ECU DIAGNOSIS >

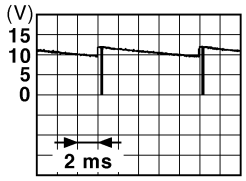
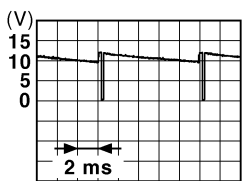
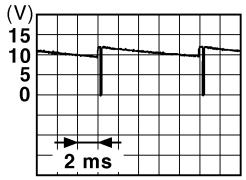
Terminal No. (Wire color)		Description		Condition	Value (Approx.)
(+)	(-)	Signal name	Input/ Output		
52 (G/B)	Ground	Combination switch OUTPUT 2	Output	Combination switch	All switch OFF (Wiper intermittent dial 4)
				Front washer switch ON (Wiper intermittent dial 4)	 <p style="text-align: right; font-size: small;">JPMIA0033GB</p>
				Any of the conditions below with all switch OFF	
					10.7V
53 (LG/ R)	Ground	Combination switch OUTPUT 3	Output	Combination switch (Wiper intermit- tent dial 4)	All switch OFF
				Lighting switch AUTO	 <p style="text-align: right; font-size: small;">JPMIA0034GB</p>
				Front wiper switch INT	
				Front wiper switch LO	
					10.7V
54 (G/Y)	Ground	Combination switch OUTPUT 4	Output	Combination switch (Wiper intermit- tent dial 4)	All switch OFF
				Turn signal switch LH	 <p style="text-align: right; font-size: small;">JPMIA0035GB</p>
				Lighting switch flash-to- pass	
				Lighting switch 2ND	
				Front fog lamp switch ON	
					10.7V
55 (BR/ W)	Ground	Front blower monitor	Input	Front blower mo- tor switch	ON
				OFF	Battery voltage
					0V
56 (L/B)	Ground	Front door lock as- sembly LH (key cylin- der switch) (lock)	Input	Front door lock assembly LH (key cylinder switch)	OFF (neutral)
					ON (lock)
					0V
57 (W)	Ground	Tire pressure warn- ing check switch	Input	—	Battery voltage
58 (SB)	Ground	Front door LH switch	Input	Front door LH switch	OFF (front door LH CLOSE)
					ON (front door LH OPEN)
					11.8V
59 (G/R)	Ground	Rear window defog- ger relay	Output	Rear window de- fogger	Active
					Not activated
					0V

A
B
C
D
E
F
G
H
I
J
K
L
PCS
N
O
P

BCM (BODY CONTROL MODULE)

< ECU DIAGNOSIS >

[POWER DISTRIBUTION SYSTEM]

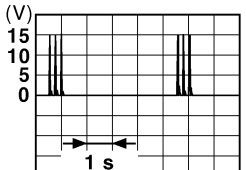
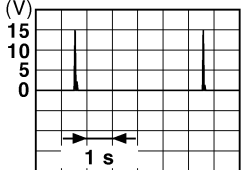
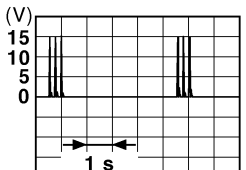
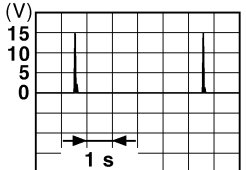
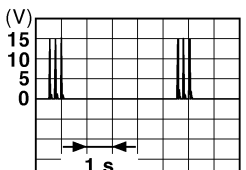
Terminal No. (Wire color)		Description		Condition	Value (Approx.)
(+)	(-)	Signal name	Input/ Output		
60 (B/R)	Ground	Front console antenna 2 (-)	Output		
				When Intelligent Key is not in the passenger compartment	 <p style="text-align: right; font-size: small;">JMKIA0063GB</p>
61 (W/R)	Ground	Center console antenna 2 (+)	Output	Ignition switch OFF	 <p style="text-align: right; font-size: small;">JMKIA0062GB</p>
				When Intelligent Key is not in the passenger compartment	 <p style="text-align: right; font-size: small;">JMKIA0063GB</p>
62 (B/Y)	Ground	Front outside handle RH antenna (-)	Output	When the front door RH request switch is operated with ignition switch OFF	 <p style="text-align: right; font-size: small;">JMKIA0062GB</p>
				When Intelligent Key is not in the antenna detection area	 <p style="text-align: right; font-size: small;">JMKIA0063GB</p>

BCM (BODY CONTROL MODULE)

< ECU DIAGNOSIS >

[POWER DISTRIBUTION SYSTEM]

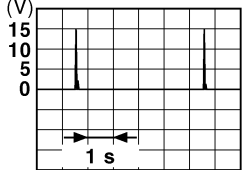
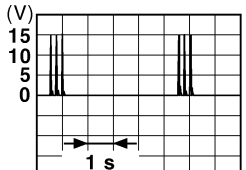
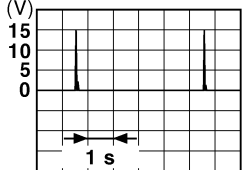
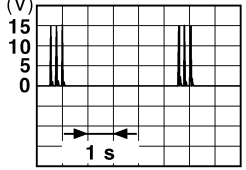
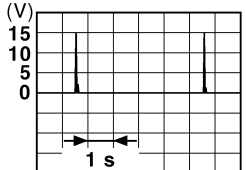
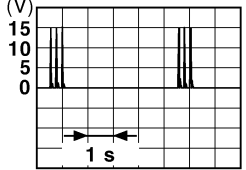
Terminal No. (Wire color)		Description		Condition	Value (Approx.)
(+)	(-)	Signal name	Input/ Output		
63 (LG)	Ground	Front outside handle RH antenna (+)	Output	When the front door RH request switch is operat- ed with ignition switch OFF	When Intelligent Key is in the antenna detection area  <small>JMKIA0062GB</small>
				When Intelligent Key is not in the antenna detection area	 <small>JMKIA0063GB</small>
64 (V)	Ground	Front outside handle LH antenna (-)	Output	When the front door LH request switch is operat- ed with ignition switch OFF	When Intelligent Key is in the antenna detection area  <small>JMKIA0062GB</small>
				When Intelligent Key is not in the antenna detection area	 <small>JMKIA0063GB</small>
65 (P)	Ground	Front outside handle LH antenna (+)	Output	When the front door LH request switch is operat- ed with ignition switch OFF	When Intelligent Key is in the antenna detection area  <small>JMKIA0062GB</small>
				When Intelligent Key is not in the antenna detection area	 <small>JMKIA0063GB</small>

A
B
C
D
E
F
G
H
I
J
K
L
N
O
P

PCS

BCM (BODY CONTROL MODULE)

< ECU DIAGNOSIS >

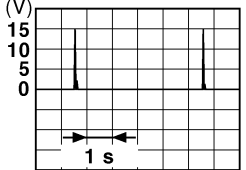
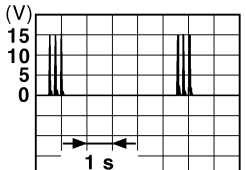
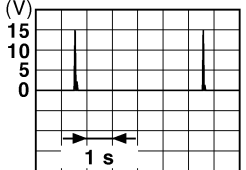
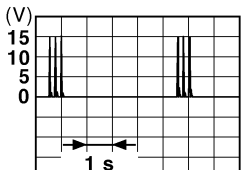

[POWER DISTRIBUTION SYSTEM]

Terminal No. (Wire color)		Description		Condition	Value (Approx.)	
(+)	(-)	Signal name	Input/ Output			
66 (R)	Ground	Instrument panel antenna (-)	Output	Ignition switch OFF	 <p style="text-align: right; font-size: small;">JMKIA0062GB</p>	
				When Intelligent Key is not in the passenger compartment	 <p style="text-align: right; font-size: small;">JMKIA0063GB</p>	
67 (G)	Ground	Instrument panel antenna (+)	Output	Ignition switch OFF	 <p style="text-align: right; font-size: small;">JMKIA0062GB</p>	
				When Intelligent Key is not in the passenger compartment	 <p style="text-align: right; font-size: small;">JMKIA0063GB</p>	
68 (G/O)	Ground	NATS antenna amp (built in key slot)	Input/ Output	During waiting	Ignition switch is pressed while inserting the Intelligent Key into the key slot.	Just after pressing ignition switch. Pointer of tester should move.
69 (O)	Ground	NATS antenna amp (built in key slot)	Input/ Output	During waiting	Ignition switch is pressed while inserting the Intelligent Key into the key slot.	Just after pressing ignition switch. Pointer of tester should move.
70 (R/B)	Ground	Ignition relay-2 control	Output	Ignition switch	OFF or ACC	0V
				ON	Battery voltage	

BCM (BODY CONTROL MODULE)

[POWER DISTRIBUTION SYSTEM]

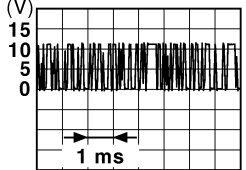
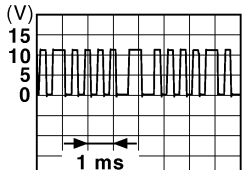
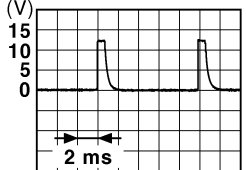
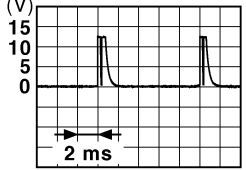
< ECU DIAGNOSIS >



Terminal No. (Wire color)		Description		Condition	Value (Approx.)
(+)	(-)	Signal name	Input/ Output		
71 (L/O)	Ground	Remote keyless entry receiver signal	Input/ Output	During waiting	 <p style="text-align: right; font-size: small;">JMKIA0064GB</p>
				When operating either button on Intelligent Key	 <p style="text-align: right; font-size: small;">JMKIA0065GB</p>
75 (R/Y)	Ground	Combination switch INPUT 5	Input	All switch OFF (Wiper intermittent dial 4)	 <p style="text-align: right; font-size: small;">JPMIA0041GB</p> <p style="text-align: center;">1.4V</p>
				Combination switch Front fog lamp switch ON (Wiper intermittent dial 4)	 <p style="text-align: right; font-size: small;">JPMIA0037GB</p> <p style="text-align: center;">1.3V</p>
				Any of the conditions below with all switch OFF	<ul style="list-style-type: none"> • Wiper intermittent dial 1 • Wiper intermittent dial 2 • Wiper intermittent dial 6 • Wiper intermittent dial 7  <p style="text-align: right; font-size: small;">JPMIA0040GB</p> <p style="text-align: center;">1.3V</p>

A
B
C
D
E
F
G
H
I
J
K
L
PCS
N
O
P

BCM (BODY CONTROL MODULE)

< ECU DIAGNOSIS >

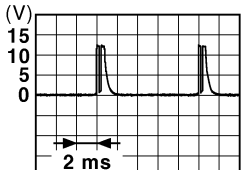
[POWER DISTRIBUTION SYSTEM]

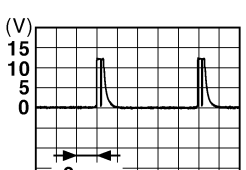
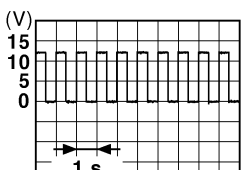
Terminal No. (Wire color)		Description		Condition	Value (Approx.)	
(+)	(-)	Signal name	Input/ Output			
76 (R/G)	Ground	Combination switch INPUT 3	Input			Combination switch
				Lighting switch high-beam (Wiper intermittent dial 4)	 <small>JPMIA0036GB</small> 1.3V	
				Lighting switch 2ND (Wiper intermittent dial 4)	 <small>JPMIA0037GB</small> 1.3V	
				Any of the conditions below with all switch OFF <ul style="list-style-type: none"> • Wiper intermittent dial 1 • Wiper intermittent dial 2 • Wiper intermittent dial 3 	 <small>JPMIA0040GB</small> 1.3V	
77 (BR)	Ground	Push-button ignition switch	Input	Engine switch (push switch)	Pressed	0V
					Not pressed	Battery voltage
78 (P)	Ground	CAN-L	Input/ Output	—	—	
79 (L)	Ground	CAN-H	Input/ Output	—	—	
80 (R/L)	Ground	Key slot illumination	Output	Key slot illumina- tion	OFF	0V
					Blinking	 <small>JPMIA0015GB</small> 6.5V
					ON	Battery voltage

BCM (BODY CONTROL MODULE)

< ECU DIAGNOSIS >

[POWER DISTRIBUTION SYSTEM]

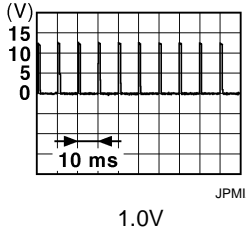
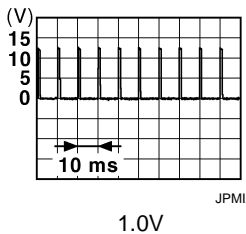
Terminal No. (Wire color)		Description		Condition		Value (Approx.)
		Signal name	Input/ Output			
(+)	(-)					
81 (LG)	Ground	ON indicator lamp	Output	Ignition switch	OFF or ACC	Battery voltage
					ON	0V
83 (L)	Ground	ACC relay control	Output	Ignition switch	OFF	0V
					ACC or ON	Battery voltage
84 (Y/R)	Ground	ECTV device (detent switch)	Output	—		Battery voltage
85 (L/O)	Ground	Electronic steering column lock condition No. 1	Input	Electronic steering column lock	Lock status	0V
					Unlock status	Battery voltage
86 (G/R)	Ground	Electronic steering column lock condition No. 2	Input	Electronic steering column lock	Lock status	Battery voltage
					Unlock status	0V
87 (G/B)	Ground	ECTV device (detent switch)	Input	Selector lever	P position	0V
					Any position other than P	Battery voltage
88 (P/L)	Ground	Front door RH request switch	Input	Front door RH request switch	ON (pressed)	0V
					OFF (not pressed)	
89 (B/W)	Ground	Front door LH request switch	Input	Front door LH request switch	ON (pressed)	0V
					OFF (not pressed)	
90 (Y)	Ground	Front blower motor relay control	Output	Ignition switch	OFF or ACC	0V
					ON	Battery voltage
91 (L/R)	Ground	Remote keyless entry receiver power supply	Output	Ignition switch OFF		Battery voltage
94 (G/Y)	Ground	Electronic steering column lock CPU power supply	Output	Ignition switch	OFF or ACC	Battery voltage
					ON	0V

A
B
C
D
E
F
G
H
I
J
K
L
PCS
N
O
P

BCM (BODY CONTROL MODULE)

[POWER DISTRIBUTION SYSTEM]

< ECU DIAGNOSIS >

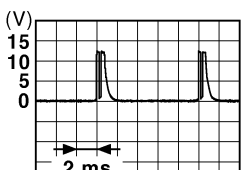
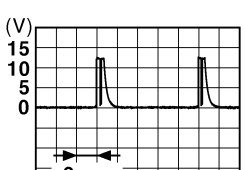
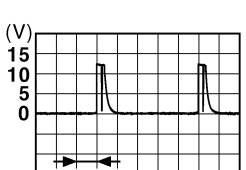
Terminal No. (Wire color)		Description		Condition	Value (Approx.)
(+)	(-)	Signal name	Input/ Output		
95 (R/W)	Ground	Combination switch INPUT 1	Input		
				Turn signal switch LH	<div style="text-align: right;">  <p style="text-align: right; margin-right: 20px;">1.3V</p> </div>
				Turn signal switch RH	<div style="text-align: right;">  <p style="text-align: right; margin-right: 20px;">1.3V</p> </div>
				Front wiper switch LO	<div style="text-align: right;">  <p style="text-align: right; margin-right: 20px;">1.3V</p> </div>
				Front washer switch ON	<div style="text-align: right;">  <p style="text-align: right; margin-right: 20px;">1.3V</p> </div>

BCM (BODY CONTROL MODULE)

[POWER DISTRIBUTION SYSTEM]

< ECU DIAGNOSIS >

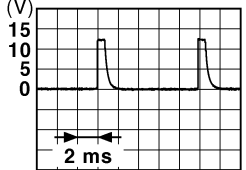
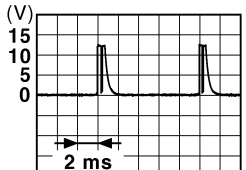
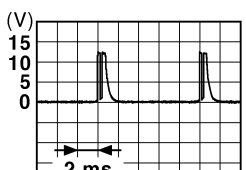
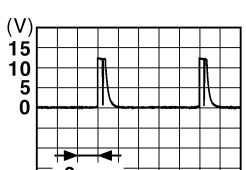
Terminal No. (Wire color)		Description		Condition	Value (Approx.)
(+)	(-)	Signal name	Input/ Output		
96 (P/B)	Ground	Combination switch INPUT 4	Input	Combination switch	All switch OFF (Wiper intermittent dial 4)  <p style="text-align: right; margin-right: 50px;">JPMIA0041GB</p> <p style="text-align: center;">1.4V</p>
					Lighting switch AUTO (Wiper intermittent dial 4)  <p style="text-align: right; margin-right: 50px;">JPMIA0038GB</p> <p style="text-align: center;">1.3V</p>
					Lighting switch 1ST (Wiper intermittent dial 4)  <p style="text-align: right; margin-right: 50px;">JPMIA0036GB</p> <p style="text-align: center;">1.3V</p>
					Any of the conditions below with all switch OFF <ul style="list-style-type: none"> • Wiper intermittent dial 1 • Wiper intermittent dial 5 • Wiper intermittent dial 6  <p style="text-align: right; margin-right: 50px;">JPMIA0039GB</p> <p style="text-align: center;">1.3V</p>

A
B
C
D
E
F
G
H
I
J
K
L



PCS

N
O
P

BCM (BODY CONTROL MODULE)

[POWER DISTRIBUTION SYSTEM]

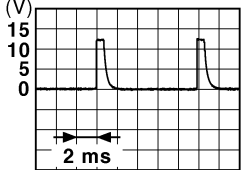
< ECU DIAGNOSIS >

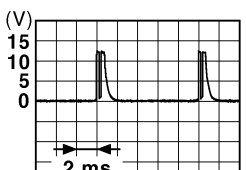
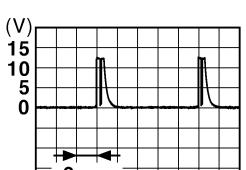
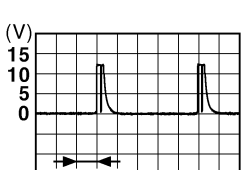
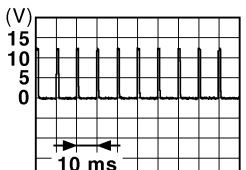
Terminal No. (Wire color)		Description		Condition	Value (Approx.)	
(+)	(-)	Signal name	Input/ Output			
97 (R/B)	Ground	Combination switch INPUT 2	Input	Combination switch (Wiper intermittent dial 4)	All switch OFF	 1.4V
					Lighting switch flash-to-pass	 1.3V
					Lighting switch 2ND	 1.3V
					Front wiper switch INT	 1.3V
					Front wiper switch HI	 1.3V
					Pressed	0 V
98 (G/R)	Ground	Hazard switch	Input	Hazard switch	Not pressed	 1.1V

BCM (BODY CONTROL MODULE)

[POWER DISTRIBUTION SYSTEM]

< ECU DIAGNOSIS >

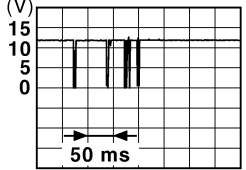
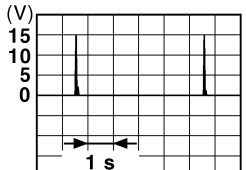
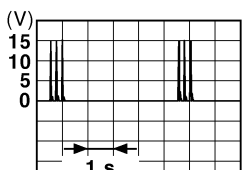
Terminal No. (Wire color)		Description		Condition	Value (Approx.)	
(+)	(-)	Signal name	Input/ Output			
99 (L/Y)	Ground	Electronic steering column lock CPU communication	Input/ Output	Electronic steering column lock	LOCK status	Battery voltage
					LOCK or UNLOCK	 <p style="text-align: right; font-size: small;">JMKIA0066GB</p>
					For 15 seconds after UN- LOCK	Battery voltage
					15 seconds or later after UNLOCK	0V
103 (V)	Ground	Trunk lid opening	Output	Trunk lid	Open (trunk lid opener ac- tuator is activated)	Battery voltage
					Close (trunk lid opener ac- tuator is not activated)	0V
110 (V/W)	Ground	Trunk room lamp	Output	Trunk room lamp	ON	0V
					OFF	Battery voltage
114 (B)	Ground	Trunk room antenna 1 (-)	Output	Ignition switch OFF	When Intelligent Key is in the passenger compart- ment	 <p style="text-align: right; font-size: small;">JMKIA0062GB</p>
					When Intelligent Key is not in the passenger compart- ment	 <p style="text-align: right; font-size: small;">JMKIA0063GB</p>

A
B
C
D
E
F
G
H
I
J
K
L
N
O
P

PCS

BCM (BODY CONTROL MODULE)

< ECU DIAGNOSIS >

[POWER DISTRIBUTION SYSTEM]

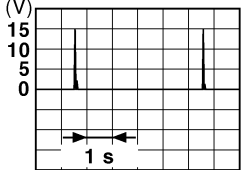
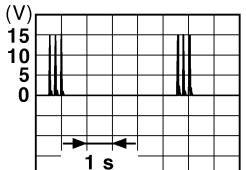
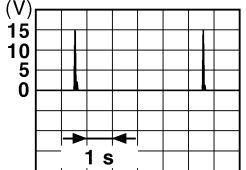
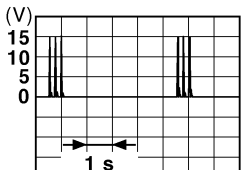
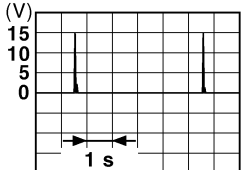
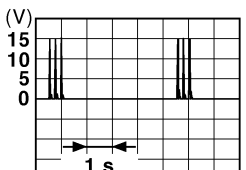
Terminal No. (Wire color)		Description		Condition	Value (Approx.)
(+)	(-)	Signal name	Input/ Output		
115 (W)	Ground	Trunk room antenna 1 (+)	Output	Ignition switch OFF	When Intelligent Key is in the passenger compart- ment  <p style="text-align: right; font-size: small;">JMKIA0062GB</p>
				When Intelligent Key is not in the passenger compart- ment  <p style="text-align: right; font-size: small;">JMKIA0063GB</p>	
118 (L/O)	Ground	Rear bumper anten- na (-)	Output	When the trunk lid request switch is operated with ignition switch OFF	When Intelligent Key is in the antenna detection area  <p style="text-align: right; font-size: small;">JMKIA0062GB</p>
				When Intelligent Key is not in the antenna detection area  <p style="text-align: right; font-size: small;">JMKIA0063GB</p>	
119 (BR/ W)	Ground	Rear bumper anten- na (+)	Output	When the trunk lid request switch is operated with ignition switch OFF	When Intelligent Key is in the antenna detection area  <p style="text-align: right; font-size: small;">JMKIA0062GB</p>
				When Intelligent Key is not in the antenna detection area  <p style="text-align: right; font-size: small;">JMKIA0063GB</p>	

BCM (BODY CONTROL MODULE)

[POWER DISTRIBUTION SYSTEM]

< ECU DIAGNOSIS >

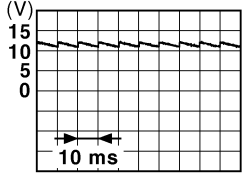
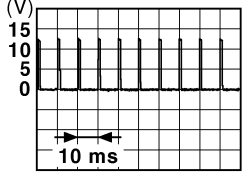
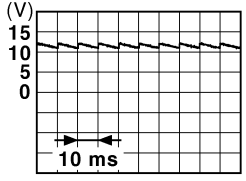
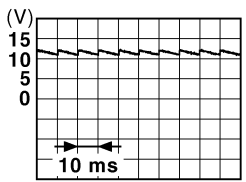
Terminal No. (Wire color)		Description		Condition	Value (Approx.)	
		Signal name	Input/ Output			
(+)	(-)					
127 (BR/ W)	Ground	Ignition relay (IPDM E/R) control	Output	Ignition switch	OFF or ACC	Battery voltage
					ON	0V
130 (Y/G)	Ground	Trunk room lamp switch	Input	Trunk room lamp switch	OFF (trunk is closed)	 <p style="text-align: right; font-size: small;">JPMIA0011GB</p> <p style="text-align: center;">11.8V</p>
					ON (trunk is open)	0V
132 (R)	Ground	Start signal	Output	Ignition switch ON	When selector lever is in P or N position and the brake peddle is not depressed	0V
					When selector lever is in P or N position and the brake peddle is depressed	Battery voltage
141 (G/R)	Ground	Trunk request switch	Input	Trunk request switch	ON (pressed)	0V
					OFF (not pressed)	 <p style="text-align: right; font-size: small;">JPMIA0016GB</p> <p style="text-align: center;">1.0V</p>
144 (GR)	Ground	Request switch buzzer	Output	Request switch buzzer	Sounding	0V
					Not sounding	Battery voltage
147 (L/R)	Ground	Trunk lid opener switch	Input	Trunk lid opener switch	Pressed	0V
					Not pressed	 <p style="text-align: right; font-size: small;">JPMIA0011GB</p> <p style="text-align: center;">11.8V</p>
148 (R/W)	Ground	Rear door RH switch	Input	Rear door RH switch	OFF (when rear door RH closes)	 <p style="text-align: right; font-size: small;">JPMIA0011GB</p> <p style="text-align: center;">11.8V</p>
					ON (when rear door RH opens)	0V

A
B
C
D
E
F
G
H
I
J
K
L
N
O
P

PCS

BCM (BODY CONTROL MODULE)

< ECU DIAGNOSIS >

[POWER DISTRIBUTION SYSTEM]

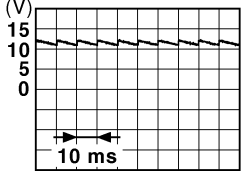
Terminal No. (Wire color)		Description		Condition		Value (Approx.)
(+)	(-)	Signal name	Input/ Output			
149 (R/B)	Ground	Rear door LH switch	Input	Rear door LH switch	OFF (when rear door LH closes)	 <p style="text-align: right; font-size: small;">JPMIA0011GB</p>
				ON (when rear door LH opens)	0V	

*: With LH and RH front window anti-pinch system

BCM (BODY CONTROL MODULE)

[POWER DISTRIBUTION SYSTEM]

< ECU DIAGNOSIS >

Wiring Diagram

INFOID:000000003301845

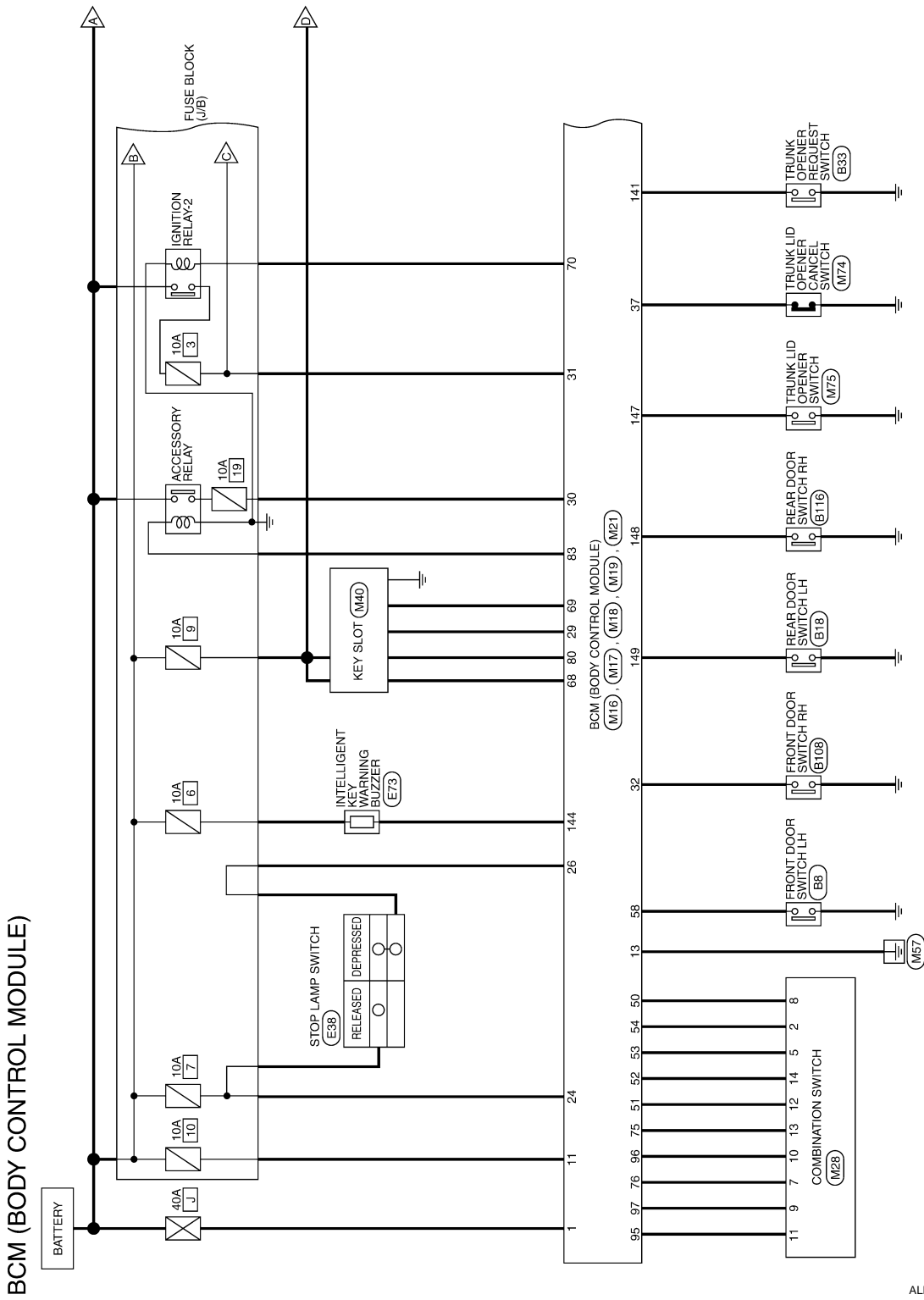

ALMWA0037GE

A
B
C
D
E
F
G
H
I
J
K
L
N
O
P

PCS

BCM (BODY CONTROL MODULE)

[POWER DISTRIBUTION SYSTEM]

< ECU DIAGNOSIS >

■ : DATA LINE

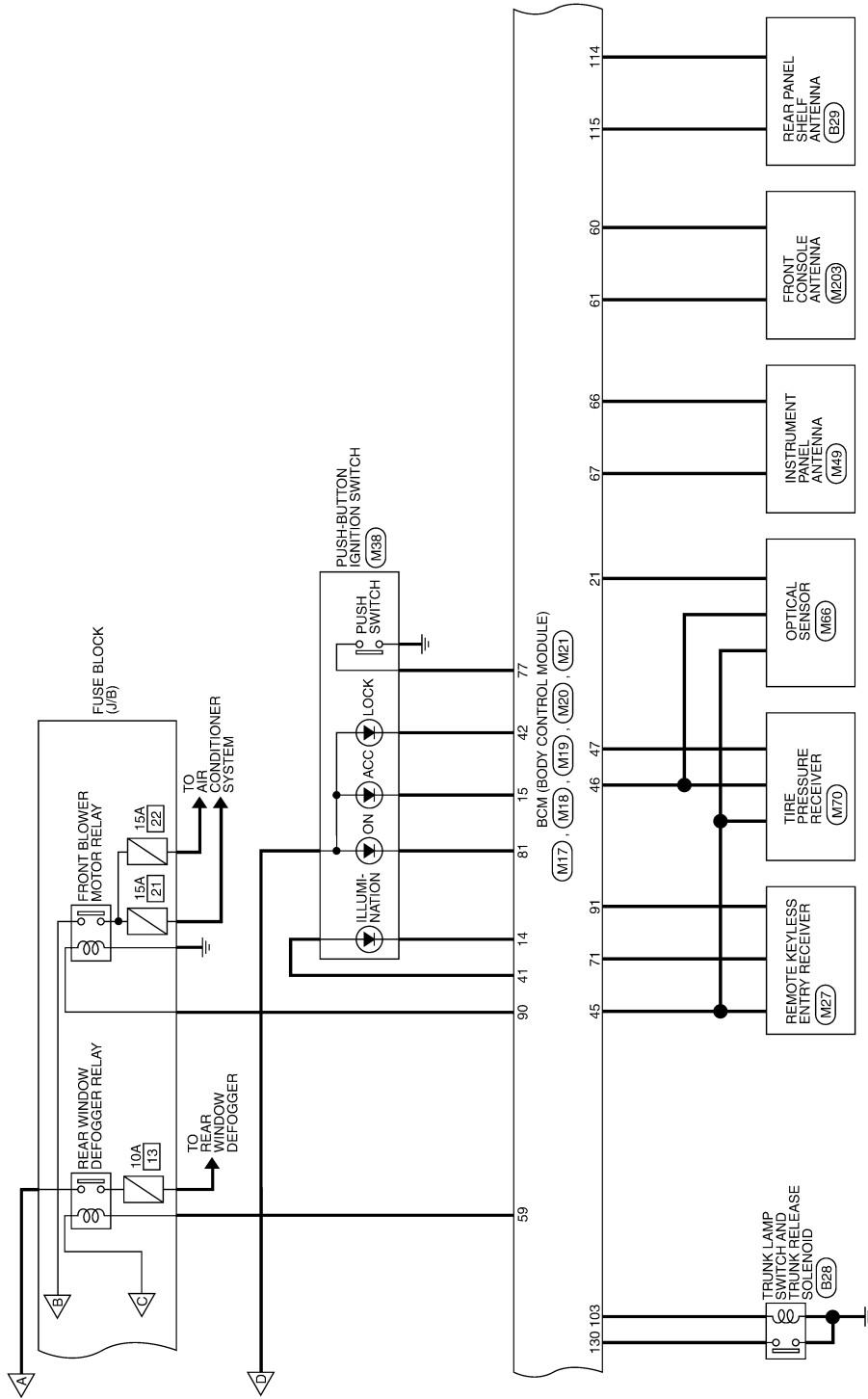

ALMWA0038Gf

BCM (BODY CONTROL MODULE)

< ECU DIAGNOSIS >

[POWER DISTRIBUTION SYSTEM]

--- : DATA LINE

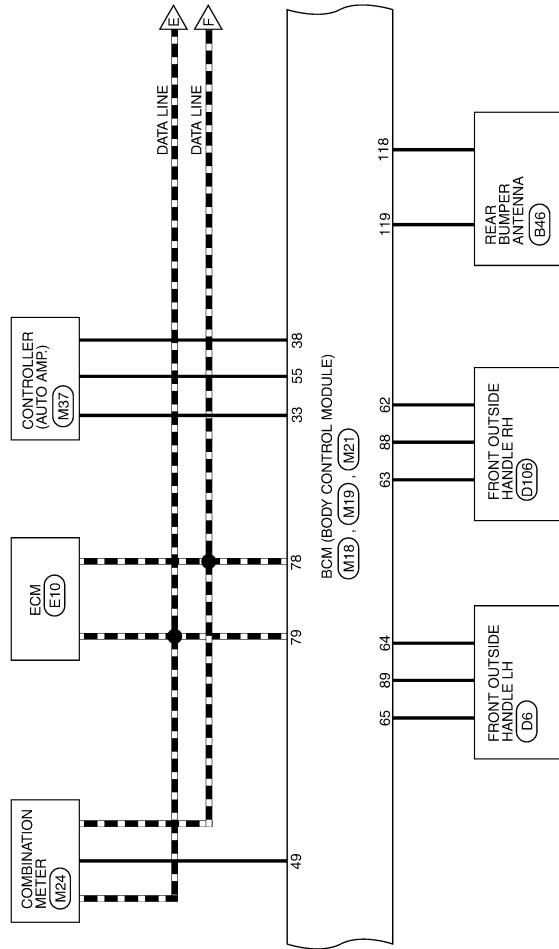

A
B
C
D
E
F
G
H
I
J
K
L
N
O
P

PCS

ALMWA0039GE

BCM (BODY CONTROL MODULE)

< ECU DIAGNOSIS >

[POWER DISTRIBUTION SYSTEM]

▬ : DATA LINE

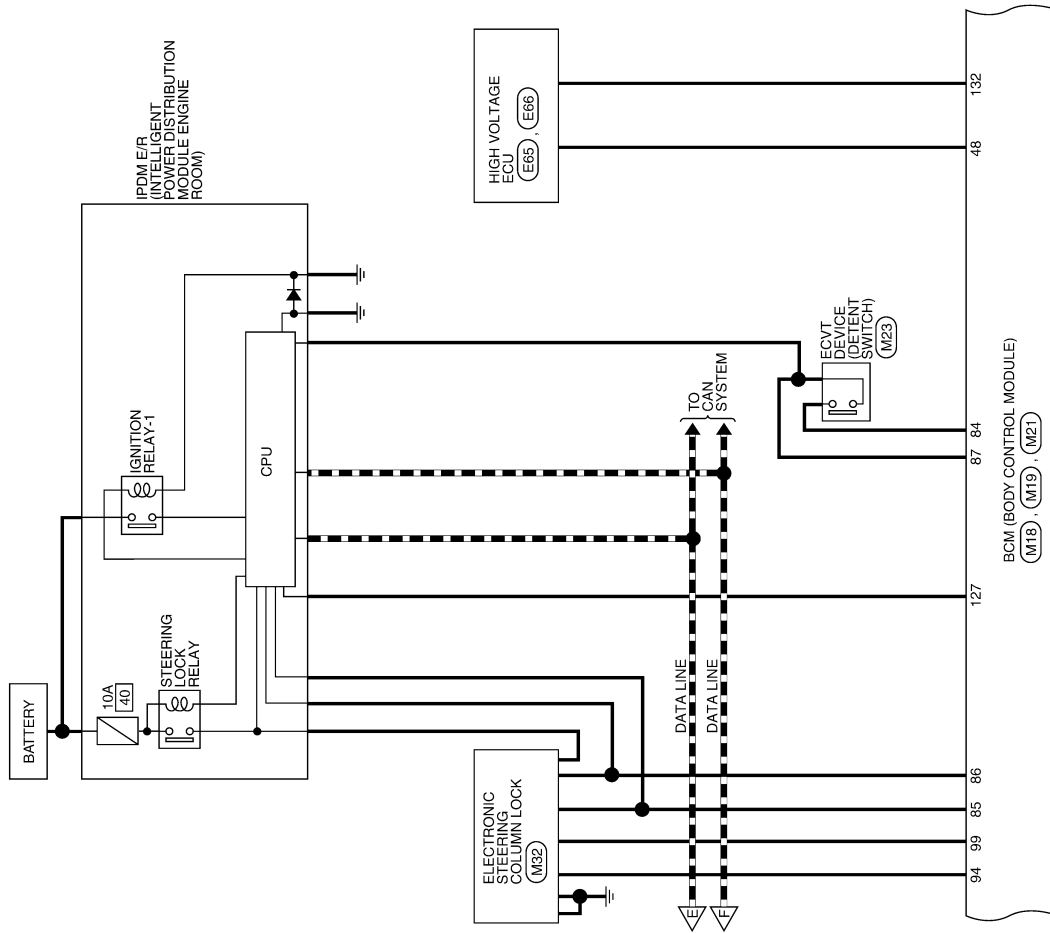

ALMWA0040GE

BCM (BODY CONTROL MODULE)

[POWER DISTRIBUTION SYSTEM]

< ECU DIAGNOSIS >

<A1> : WITH LEFT FRONT ONLY POWER WINDOW ANTI-PINCH SYSTEM
 <A2> : WITH LEFT AND RIGHT FRONT POWER WINDOW ANTI-PINCH SYSTEM

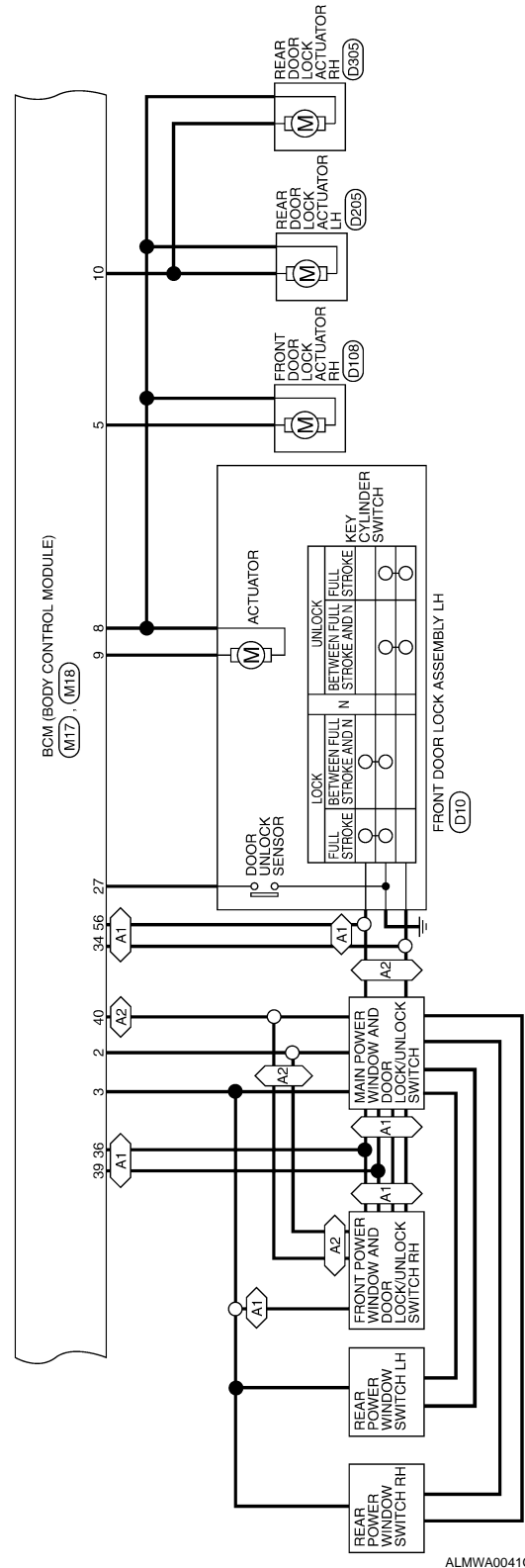

ALMWA0041GE

A
B
C
D
E
F
G
H
I
J
K
L
M
N
O
P

PCS

BCM (BODY CONTROL MODULE)

[POWER DISTRIBUTION SYSTEM]

< ECU DIAGNOSIS >

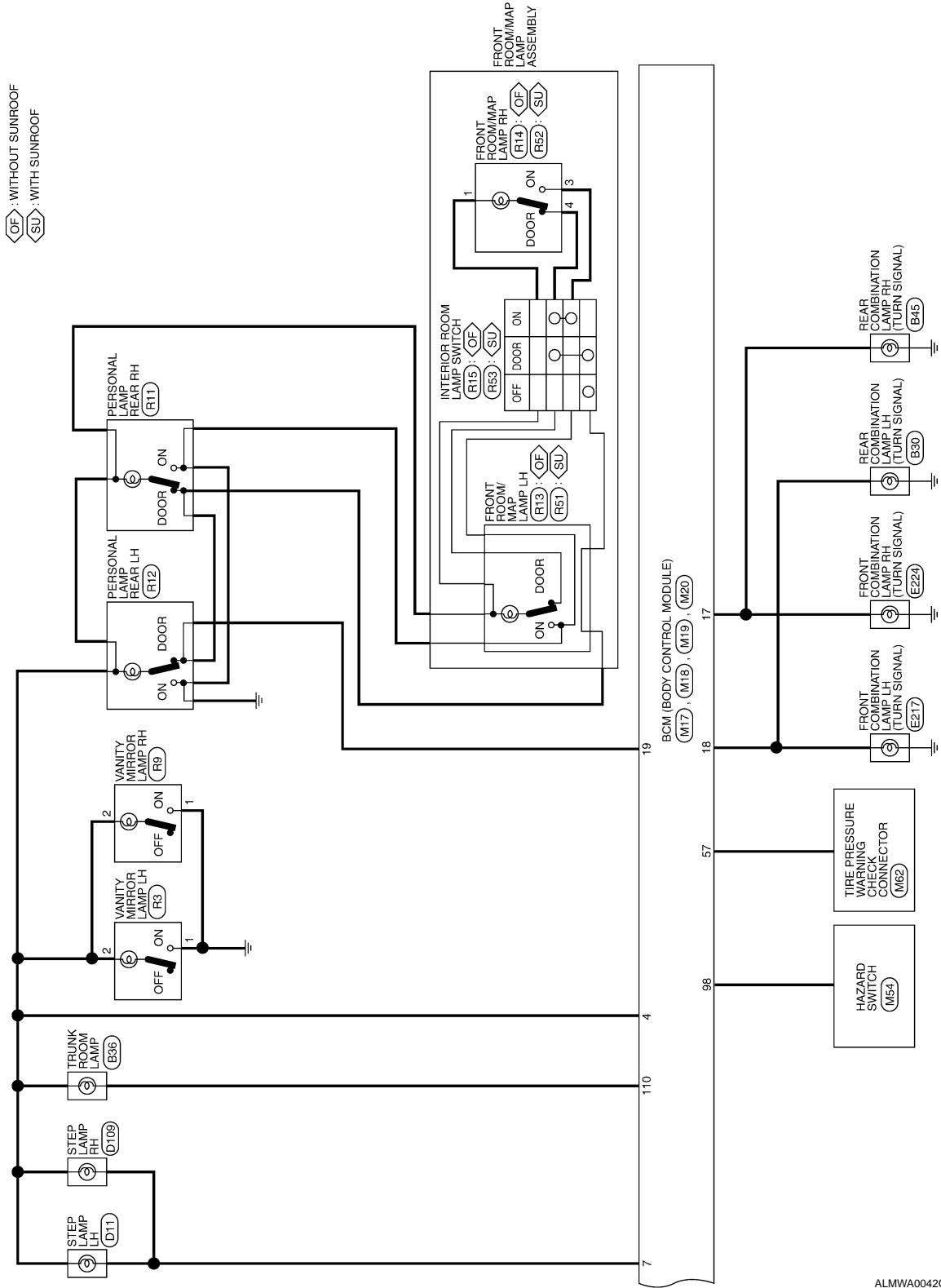

ALMWA0042Gf

BCM (BODY CONTROL MODULE)

[POWER DISTRIBUTION SYSTEM]

< ECU DIAGNOSIS >

Connector No.	M16
Connector Name	BCM (BODY CONTROL MODULE)
Connector Color	BLACK



Terminal No.	Color of Wire	Signal Name
1	W/B	BAT_POWER_F/L
2	R/Y	PW_POWER_SUPPL Y_PERM
3	L/W	POWER_WINDOW_ POWER_SUPPLY (RAP)

Connector No.	M17
Connector Name	BCM (BODY CONTROL MODULE)
Connector Color	WHITE



Terminal No.	Color of Wire	Signal Name
4	P/W	ROOM_LAMP_BAT_ SAVER
5	G/Y	CDL_AS
6	-	-
7	R/W	STEP_LAMP_OUTPUT
8	V	CDL_COMMON

Terminal No.	Color of Wire	Signal Name
9	G	CDL_DR/FL
10	G/Y	CDL_FR_RL_BACK
11	Y/R	BAT_BCM_FUSE
12	-	-
13	B	GND1
14	R/Y	LOW_SIDE_PUSH_LE D_OUTPUT
15	Y/L	ACC_LED
16	-	-
17	G/B	FR_FLASHER
18	G/O	FL_FLASHER
19	Y	ROOM_LAMP_OUTPUT

Connector No.	M18
Connector Name	BCM (BODY CONTROL MODULE)
Connector Color	GREEN



Terminal No.	Color of Wire	Signal Name
20	-	-
21	P/B	AUTO_LIGHT_SENSEN R_INPUT1
22	-	-
23	-	-
24	R/W	STOP_LAMP_LOW_SW
25	-	-
26	O/L	STOP_LAMP_HIGH_SW

Terminal No.	Color of Wire	Signal Name
27	G/W	DOOR_LOCK_STATUS
28	-	-
29	Y	FOB_IN_SW_1
30	V/Y	ACC_F/B
31	G	IGN_F/B
32	R/B	AS_DOOR_SW
33	SB	AIRCON_SW
34	L/R	DOOR_KEY/C_ UNLOCK_SW
35	-	-
36	GR	CENTRAL_LOCK_SW
37	O	TRUNK_CANCEL_SW
38	GR/W	REAR_DEFOGGER_SW
39	GR/R	CENTRAL_UNLOCK_SW
40	Y/G	PW_K-LINE
41	W	PUSH_LED
42	R	S/L_LOCK_LED
43	-	-
44	-	-
45	P	GND_RF2_AVL
46	V/W	A/L_SENS_KEYLESS_ TUNER_POWER_SUP PLY

Terminal No.	Color of Wire	Signal Name
47	G/O	KEYLESS_TUNER_SI
48	R/B	SHIFT_N/P
49	L/O	IMMO_LED
50	LG/B	INPUT_5
51	L/W	INPUT_1
52	G/B	INPUT_2
53	LG/R	INPUT_3
54	G/Y	INPUT_4
55	BR/W	BLOWER_FAN_SW/ DOOR_KEY/C_ LOCK_SW
56	L/B	TPMS_MODE_TRIGGE R_SW
57	W	DR_DOOR_SW
58	SB	REAR_DEFOGGER_ RLY
59	G/R	-

ALMIA0083GB

BCM (BODY CONTROL MODULE)

[POWER DISTRIBUTION SYSTEM]

< ECU DIAGNOSIS >

Connector No.	M19
Connector Name	BCM (BODY CONTROL MODULE)
Connector Color	BLACK



79	78	77	76	75	74	73	72	71	70	69	68	67	66	65	64	63	62	61	60
99	98	97	96	95	94	93	92	91	90	89	88	87	86	85	84	83	82	81	80

Terminal No.	Color of Wire	Signal Name
60	B/R	ROOM_ANT_2_B
61	W/R	ROOM_ANT_2_A

Terminal No.	Color of Wire	Signal Name
82	-	-
83	L	ACC_CONT
84	Y/R	AT_DEVICE_OUT
85	L/O	S/L_CONDITION_1
86	G/R	S/L_CONDITION_2
87	G/B	SHIFT_P
88	P/L	AS_REQUEST_SWITCH
89	B/W	DR_REQUEST_SWITCH
90	Y	IGN2_CONT
91	L/R	RF1_POWER_SUPPLY
92	-	-
93	-	-
94	G/Y	S/L_POWER_SUPPLY_12V
95	R/W	OUTPUT_1
96	P/B	OUTPUT_4
97	R/B	OUTPUT_2
98	G/R	HAZARD_SW
99	L/Y	S/L_K-LINE

Terminal No.	Color of Wire	Signal Name
62	B/Y	AS_DOOR_ANT_B
63	LG	AS_DOOR_ANT_A
64	V	DR_DOOR_ANT_B
65	P	DR_DOOR_ANT_A
66	R	ROOM_ANT_1_B
67	G	ROOM_ANT_1_A
68	G/O	FOB_READER_CLOCK
69	O	FOB_READER_DATA
70	R/B	IGN_ELEC_CONT
71	L/O	RF1_TUNER_SIGNAL
72	-	-
73	-	-
75	R/Y	OUTPUT_5
76	R/G	OUTPUT_3
77	BR	ENG_START_SW
78	P	CAN-L
79	L	CAN-H
80	R/L	FOB_SLOT_ILLUMINATION
81	LG	IGN_ON_LED

Connector No.	M20
Connector Name	BCM (BODY CONTROL MODULE)
Connector Color	WHITE



100	101	102	103	104		
105	106	107	108	109	110	111

Terminal No.	Color of Wire	Signal Name
100	-	-
101	-	-
102	-	-
103	V	CDL_BACK_TRUNK
104	-	-
105	-	-
106	-	-
107	-	-
108	-	-
109	-	-
110	V/W	TRUNK_LAMP_OUTPUT
111	-	-

ALMIA0084GB

BCM (BODY CONTROL MODULE)

< ECU DIAGNOSIS >

[POWER DISTRIBUTION SYSTEM]

A
B
C
D
E
F
G
H
I
J
K
L
N
O
P

Terminal No.	Color of Wire	Signal Name
119	BR/W	BACK_DOOR_ANT_A
120	-	-
121	-	-
122	-	-
123	-	-
124	-	-
125	-	-
126	-	-
127	BR/W	IGN_USM_CONT1
128	-	-
129	-	-
130	Y/G	TRUNK_SW
131	-	-
132	R	ST_CONT_USM
133	-	-
134	-	-
135	-	-
136	-	-
137	-	-
138	-	-
139	-	-
140	-	-
141	G/R	TRUNK_REQUEST_SW
142	-	-
143	-	-
144	GR	BUZZER
145	-	-
146	-	-
147	L/R	BACK_TRUNK_OPENER
148	R/W	RR_DOOR_SW
149	R/B	RL_DOOR_SW
150	-	-
151	-	-

Connector No.	M21
Connector Name	BCM (BODY CONTROL MODULE)
Connector Color	GRAY

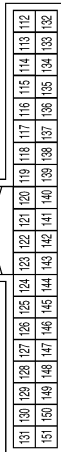

Terminal No.	Color of Wire	Signal Name
112	-	-
113	-	-
114	B	TRUNK_ANT_1_B
115	W	TRUNK_ANT_1_A
116	-	-
117	-	-
118	L/O	BACK_DOOR_ANT_B

ALMIA0085GB

INFOID:000000003301846

Fail Safe

Display contents of CONSULT	Fail-safe	Cancellation
B2013: ID DISCORD BCM-S/L	Inhibit hybrid system cranking	Erase DTC
B2014: CHAIN OF S/L-BCM	Inhibit hybrid system cranking	Erase DTC

BCM (BODY CONTROL MODULE)

< ECU DIAGNOSIS >

[POWER DISTRIBUTION SYSTEM]

Display contents of CONSULT	Fail-safe	Cancellation
B2190: NATS ANTENNA AMP	Inhibit hybrid system cranking	Erase DTC
B2191: DIFFERENCE OF KEY	Inhibit hybrid system cranking	Erase DTC
B2192: ID DISCORD BCM-ECM	Inhibit hybrid system cranking	Erase DTC
B2193: CHAIN OF BCM-ECM	Inhibit hybrid system cranking	Erase DTC
B2195: ANTI-SCANNING	Inhibit hybrid system cranking	Erase DTC
B2557: VEHICLE SPEED	Inhibit electronic steering column lock	When normal vehicle speed signals have been received from brake ECU actuator and electric unit (control unit) for 500 ms
B2560: STARTER CONT RELAY	Inhibit hybrid system cranking	500 ms after the following CAN signal communication status has become consistent <ul style="list-style-type: none"> • Starter control relay signal • Starter relay status signal
B2562: LOW VOLTAGE	<ul style="list-style-type: none"> • Inhibit hybrid system cranking • Inhibit electronic steering column lock 	100 ms after the power supply voltage increases to more than 8.8 V
B2563: HI VOLTAGE	<ul style="list-style-type: none"> • Inhibit hybrid system cranking • Inhibit electronic steering column lock 	500 ms after the power supply voltage decreases to less than 18 V
B2601: SHIFT POSITION	Inhibit electronic steering column lock	500 ms after the following signal reception status becomes consistent <ul style="list-style-type: none"> • Selector lever P position switch signal • P range signal (CAN)
B2602: SHIFT POSITION	Inhibit electronic steering column lock	5 seconds after the following BCM recognition conditions are fulfilled <ul style="list-style-type: none"> • Ignition switch is in the ON position • Selector lever P position switch signal: Except P position (battery voltage) • Vehicle speed: 4 /h or more
B2603: SHIFT POSI STATUS	Inhibit electronic steering column lock	500 ms after the following BCM recognition conditions are fulfilled <ul style="list-style-type: none"> • Ignition switch is in the ON position • Selector lever P position switch signal: Except P position (battery voltage) • Selector lever P/N position signal: Except P and N positions (0 V)
B2604: PNP SW	Inhibit electronic steering column lock	500 ms after any of the following BCM recognition conditions is fulfilled <ul style="list-style-type: none"> • Status 1 <ul style="list-style-type: none"> - Ignition switch is in the ON position - Selector lever P/N position signal: P and N position (battery voltage) - P range signal or N range signal (CAN): ON • Status 2 <ul style="list-style-type: none"> - Ignition switch is in the ON position - Selector lever P/N position signal: Except P and N positions (0 V) - P range signal and N range signal (CAN): OFF

BCM (BODY CONTROL MODULE)

[POWER DISTRIBUTION SYSTEM]

< ECU DIAGNOSIS >

Display contents of CONSULT	Fail-safe	Cancellation
B2605: PNP SW	Inhibit electronic steering column lock	500 ms after any of the following BCM recognition conditions is fulfilled <ul style="list-style-type: none"> Ignition switch is in the ON position Power position: IGN Selector lever P/N position signal: Except P and N positions (0 V) Interlock/PNP switch signal (CAN): OFF Status 2 Ignition switch is in the ON position Selector lever P/N position signal: P or N position (battery voltage) PNP switch signal (CAN): ON
B2606: S/L RELAY	Inhibit hybrid system cranking	500 ms after the following CAN signal communication status has become consistent <ul style="list-style-type: none"> Electronic steering column lock relay signal (Request signal) Electronic steering column lock relay signal (Condition signal)
B2607: S/L RELAY	Inhibit hybrid system cranking	500 ms after the following CAN signal communication status has become consistent <ul style="list-style-type: none"> Electronic steering column lock relay signal (Request signal) Electronic steering column lock relay signal (Condition signal)
B2608: STARTER RELAY	Inhibit hybrid system cranking	500 ms after the following signal communication status becomes consistent <ul style="list-style-type: none"> Starter motor relay control signal Starter relay status signal (CAN)
B2609: S/L STATUS	<ul style="list-style-type: none"> Inhibit hybrid system cranking Inhibit electronic steering column lock 	When the following electronic steering column lock conditions agree <ul style="list-style-type: none"> BCM electronic steering column lock control status Electronic steering column lock condition No. 1 signal status Electronic steering column lock condition No. 2 signal status
B260A: IGNITION RELAY	Inhibit hybrid system cranking	500 ms after the following conditions are fulfilled <ul style="list-style-type: none"> IGN relay (IPDM E/R) control signal: OFF (Battery voltage) Ignition ON signal (CAN to IPDM E/R): OFF (Request signal) Ignition ON signal (CAN from IPDM E/R): OFF (Condition signal)
B260F: ENG STATE SIG LOST	Maintains the power supply position attained at the time of DTC detection	When any of the following conditions is fulfilled <ul style="list-style-type: none"> Power position changes to ACC Receives hybrid system status signal (CAN)
B2612: S/L STATUS	<ul style="list-style-type: none"> Inhibit hybrid system cranking Inhibit electronic steering column lock 	When any of the following conditions is fulfilled <ul style="list-style-type: none"> Electronic steering column lock unit status signal (CAN) is received normally The BCM electronic steering column lock control status matches the electronic steering column lock status recognized by the electronic steering column lock unit status signal (CAN from IPDM E/R)
B2617: STARTER RELAY CIRC	Inhibit hybrid system cranking	1 second after the starter motor relay control inside BCM becomes normal
B2618: BCM	Inhibit hybrid system cranking	1 second after the ignition relay (IPDM E/R) control inside BCM becomes normal
B2619: BCM	Inhibit hybrid system cranking	1 second after the electronic steering column lock unit power supply output control inside BCM becomes normal
B261E: VEHICLE TYPE	Inhibit hybrid system cranking	BCM initialization
B26E1: ENG STATE NO RECIV	Inhibit hybrid system cranking	When any of the following conditions is fulfilled <ul style="list-style-type: none"> Power position changes to ACC Receives hybrid system status signal (CAN)

A
B
C
D
E
F
G
H
I
J
K
L
PCS
N
O
P

DTC Inspection Priority Chart

INFOID:000000003301847

If some DTCs are displayed at the same time, perform inspections one by one based on the following priority chart.

BCM (BODY CONTROL MODULE)

[POWER DISTRIBUTION SYSTEM]

< ECU DIAGNOSIS >

Priority	DTC
1	<ul style="list-style-type: none">• B2562: LOW VOLTAGE• B2563: HI VOLTAGE• B261E: VEHICLE TYPE
2	<ul style="list-style-type: none">• U1000: CAN COMM CIRCUIT• U1010: CONTROL UNIT (CAN)
3	<ul style="list-style-type: none">• B2190: NATS ANTENNA AMP• B2191: DIFFERENCE OF KEY• B2192: ID DISCORD BCM-ECM• B2193: CHAIN OF BCM-ECM
4	<ul style="list-style-type: none">• B2013: ID DISCORD BCM-S/L• B2014: CHAIN OF S/L-BCM• B2553: IGNITION RELAY• B2555: STOP LAMP• B2556: PUSH-BTN IGN SW• B2557: VEHICLE SPEED• B2560: STARTER CONT RELAY• B2601: SHIFT POSITION• B2602: SHIFT POSITION• B2603: SHIFT POSI STATUS• B2604: PNP SW• B2605: PNP SW• B2606: S/L RELAY• B2607: S/L RELAY• B2608: STARTER RELAY• B2609: S/L STATUS• B260A: IGNITION RELAY• B260B: STEERING LOCK UNIT• B260C: STEERING LOCK UNIT• B260D: STEERING LOCK UNIT• B260F: ENG STATE SIG LOST• B2611: ACC RELAY• B2612: S/L STATUS• B2614: ACC RELAY CIRC• B2615: BLOWER RELAY CIRC• B2616: IGN RELAY CIRC• B2617: STARTER RELAY CIRC• B2618: BCM• B2619: BCM• B261A: PUSH-BTN IGN SW• B26E1: ENG STATE NO RECIV• C1729: VHCL SPEED SIG ERR• U0415: VEHICLE SPEED SIG

BCM (BODY CONTROL MODULE)

[POWER DISTRIBUTION SYSTEM]

< ECU DIAGNOSIS >

Priority	DTC
5	<ul style="list-style-type: none"> • C1704: LOW PRESSURE FL • C1705: LOW PRESSURE FR • C1706: LOW PRESSURE RR • C1707: LOW PRESSURE RL • C1708: [NO DATA] FL • C1709: [NO DATA] FR • C1710: [NO DATA] RR • C1711: [NO DATA] RL • C1712: [CHECKSUM ERR] FL • C1713: [CHECKSUM ERR] FR • C1714: [CHECKSUM ERR] RR • C1715: [CHECKSUM ERR] RL • C1716: [PRESSDATA ERR] FL • C1717: [PRESSDATA ERR] FR • C1718: [PRESSDATA ERR] RR • C1719: [PRESSDATA ERR] RL • C1720: [CODE ERR] FL • C1721: [CODE ERR] FR • C1722: [CODE ERR] RR • C1723: [CODE ERR] RL • C1724: [BATT VOLT LOW] FL • C1725: [BATT VOLT LOW] FR • C1726: [BATT VOLT LOW] RR • C1727: [BATT VOLT LOW] RL • C1734: CONTROL UNIT
6	<ul style="list-style-type: none"> • B2621: INSIDE ANTENNA • B2622: INSIDE ANTENNA • B2623: INSIDE ANTENNA

DTC Index

INFOID:000000003301848

NOTE:

- Details of time display
- CRNT: Displays when there is a malfunction now or after returning to the normal condition until turning ignition switch OFF → ON again.
- 1 - 39: Displayed if any previous malfunction is present when current condition is normal. It increases like 1 → 2 → 3...38 → 39 after returning to the normal condition whenever ignition switch OFF → ON. The counter remains at 39 even if the number of cycles exceeds it. It is counted from 1 again when turning ignition switch OFF → ON after returning to the normal condition if the malfunction is detected again.

CONSULT display	Fail-safe	Intelligent Key warning lamp ON	Tire pressure monitor warning lamp ON	Reference page
No DTC is detected. further testing may be required.	—	—	—	—
U1000: CAN COMM CIRCUIT	—	—	—	PCS-45
U1010: CONTROL UNIT (CAN)	—	—	—	PCS-46
U0415: VEHICLE SPEED SIG	—	—	—	BCS-38
B2013: ID DISCORD BCM-S/L	×	—	—	SEC-35
B2014: CHAIN OF S/L-BCM	×	—	—	SEC-36
B2190: NATS ANTENNA AMP	×	—	—	SEC-28
B2191: DIFFERENCE OF KEY	×	—	—	SEC-32
B2192: ID DISCORD BCM-ECM	×	—	—	SEC-33
B2193: CHAIN OF BCM-ECM	×	—	—	SEC-34
B2553: IGNITION RELAY	—	—	—	PCS-47
B2555: STOP LAMP	—	—	—	SEC-40

BCM (BODY CONTROL MODULE)

< ECU DIAGNOSIS >

[POWER DISTRIBUTION SYSTEM]

CONSULT display	Fail-safe	Intelligent Key warning lamp ON	Tire pressure monitor warning lamp ON	Reference page
B2556: PUSH-BTN IGN SW	—	×	—	SEC-43
B2557: VEHICLE SPEED	×	×	—	SEC-45
B2560: STARTER CONT RELAY	×	×	—	SEC-46
B2562: LOW VOLTAGE	—	—	—	BCS-39
B2563: HI VOLTAGE	×	×	—	BCS-40
B2601: SHIFT POSITION	×	×	—	SEC-47
B2602: SHIFT POSITION	×	×	—	SEC-51
B2603: SHIFT POSI STATUS	×	×	—	SEC-54
B2604: PNP SW	×	×	—	SEC-58
B2607: S/L RELAY	×	×	—	SEC-60
B2608: STARTER RELAY	×	×	—	SEC-62
B2609: S/L STATUS	×	×	—	SEC-64
B260A: IGNITION RELAY	×	×	—	PCS-49
B260B: STEERING LOCK UNIT	—	×	—	SEC-69
B260C: STEERING LOCK UNIT	—	×	—	SEC-70
B260D: STEERING LOCK UNIT	—	×	—	SEC-71
B260F: ENG STATE SIG LOST	×	×	—	SEC-72
B2611: ACC RELAY	—	—	—	PCS-50
B2612: S/L STATUS	×	×	—	SEC-73
B2614: ACC RELAY CIRC	—	×	—	PCS-52
B2615: BLOWER RELAY CIRC	—	×	—	PCS-55
B2616: IGN RELAY CIRC	—	×	—	PCS-58
B2617: STARTER RELAY CIRC	×	×	—	SEC-78
B2618: BCM	×	×	—	PCS-61
B2619: BCM	×	×	—	SEC-80
B261A: PUSH-BTN IGN SW	—	×	—	SEC-81
B261E: VEHICLE TYPE	×	× (Turn ON for 15 seconds)	—	SEC-84
B2621: INSIDE ANTENNA	—	—	—	DLK-42
B2622: INSIDE ANTENNA	—	—	—	DLK-45
B2623: INSIDE ANTENNA	—	—	—	DLK-48
C1704: LOW PRESSURE FL	—	—	×	WT-8
C1705: LOW PRESSURE FR	—	—	×	WT-8
C1706: LOW PRESSURE RR	—	—	×	WT-8
C1707: LOW PRESSURE RL	—	—	×	WT-8
C1708: [NO DATA] FL	—	—	×	WT-13
C1709: [NO DATA] FR	—	—	×	WT-13
C1710: [NO DATA] RR	—	—	×	WT-13
C1711: [NO DATA] RL	—	—	×	WT-13
C1712: [CHECKSUM ERR] FL	—	—	×	WT-14
C1713: [CHECKSUM ERR] FR	—	—	×	WT-14
C1714: [CHECKSUM ERR] RR	—	—	×	WT-14
C1715: [CHECKSUM ERR] RL	—	—	×	WT-14

BCM (BODY CONTROL MODULE)

< ECU DIAGNOSIS >

[POWER DISTRIBUTION SYSTEM]

CONSULT display	Fail-safe	Intelligent Key warning lamp ON	Tire pressure monitor warning lamp ON	Reference page
C1716: [PRESSDATA ERR] FL	—	—	×	WT-15
C1717: [PRESSDATA ERR] FR	—	—	×	WT-15
C1718: [PRESSDATA ERR] RR	—	—	×	WT-15
C1719: [PRESSDATA ERR] RL	—	—	×	WT-15
C1720: [CODE ERR] FL	—	—	×	WT-14
C1721: [CODE ERR] FR	—	—	×	WT-14
C1722: [CODE ERR] RR	—	—	×	WT-14
C1723: [CODE ERR] RL	—	—	×	WT-14
C1724: [BATT VOLT LOW] FL	—	—	×	WT-14
C1725: [BATT VOLT LOW] FR	—	—	×	WT-14
C1726: [BATT VOLT LOW] RR	—	—	×	WT-14
C1727: [BATT VOLT LOW] RL	—	—	×	WT-14
C1729: VHCL SPEED SIG ERR	—	—	×	WT-16

A
B
C
D
E
F
G
H
I
J
K
L
N
O
P

PCS

IPDM E/R (INTELLIGENT POWER DISTRIBUTION MODULE ENGINE ROOM)

< ECU DIAGNOSIS >

[POWER DISTRIBUTION SYSTEM]

IPDM E/R (INTELLIGENT POWER DISTRIBUTION MODULE ENGINE ROOM)

Reference Value

INFOID:000000003301857

VALUES ON THE DIAGNOSIS TOOL

Monitor Item	Condition		Value/Status
RADFAN REQ	Engine idle speed	Changes depending on engine coolant temperature, air conditioner operation status, vehicle speed, etc.	0 - 100 %
TAIL&CLR REQ	Lighting switch OFF		OFF
	Lighting switch 1ST, 2ND, HI or AUTO (Light is illuminated)		ON
HL LO REQ	Lighting switch OFF		OFF
	Lighting switch 2ND HI or AUTO (Light is illuminated)		ON
HL HI REQ	Lighting switch OFF		OFF
	Lighting switch HI		ON
FR FOG REQ	Lighting switch 2ND or AUTO (Light is illuminated)	Front fog lamp switch OFF	OFF
		<ul style="list-style-type: none"> • Front fog lamp switch ON • Daytime light activated (Canada only) 	ON
FR WIP REQ	Ignition switch ON	Front wiper switch OFF	STOP
		Front wiper switch INT	1LOW
		Front wiper switch LO	LOW
		Front wiper switch HI	HI
WIP AUTO STOP	Ignition switch ON	Front wiper stop position	STOP P
		Any position other than front wiper stop position	ACT P
WIP PROT	Ignition switch ON	Front wiper operates normally	OFF
		Front wiper stops at fail-safe operation	BLOCK
IGN RLY1 -REQ	Ignition switch OFF or ACC		OFF
	Ignition switch ON		ON
IGN RLY	Ignition switch OFF or ACC		OFF
	Ignition switch ON		ON
PUSH SW	Release the push-button ignition switch		OFF
	Press the push-button ignition switch		ON
DETENT SW	Ignition switch ON	<ul style="list-style-type: none"> • Press the selector button with CVT selector lever in P position • CVT selector lever in any position other than P 	OFF
		Release the CVT selector button with CVT selector lever in P position	
S/L RLY -REQ	None of the conditions below are present		OFF
	<ul style="list-style-type: none"> • Open the front door LH after the ignition switch is turned OFF (for a few seconds) • Press the push-button ignition switch when the steering lock is activated 		ON

IPDM E/R (INTELLIGENT POWER DISTRIBUTION MODULE ENGINE ROOM)

< ECU DIAGNOSIS >

[POWER DISTRIBUTION SYSTEM]

Monitor Item	Condition	Value/Status
S/L STATE	Steering lock is activated	LOCK
	Steering lock is deactivated	UNLK
	[DTC B210A] is detected	UNKWN
DTRL REQ	NOTE: This item is displayed, but cannot be monitored.	OFF
OIL P SW	Ignition switch OFF, ACC or engine running	OPEN
	Ignition switch ON	CLOSE
THFT HRN REQ	Not operated	OFF
	<ul style="list-style-type: none"> Panic alarm is activated Horn is activated with VEHICLE SECURITY (THEFT WARNING) SYSTEM 	ON
HORN CHIRP	Not operated	OFF
	Door locking with Intelligent Key (horn chirp mode)	ON
CRNRNG LMP REQ	NOTE: This item is displayed, but cannot be monitored.	OFF

Terminal Layout

INFOID:000000003301858

TERMINAL LAYOUT

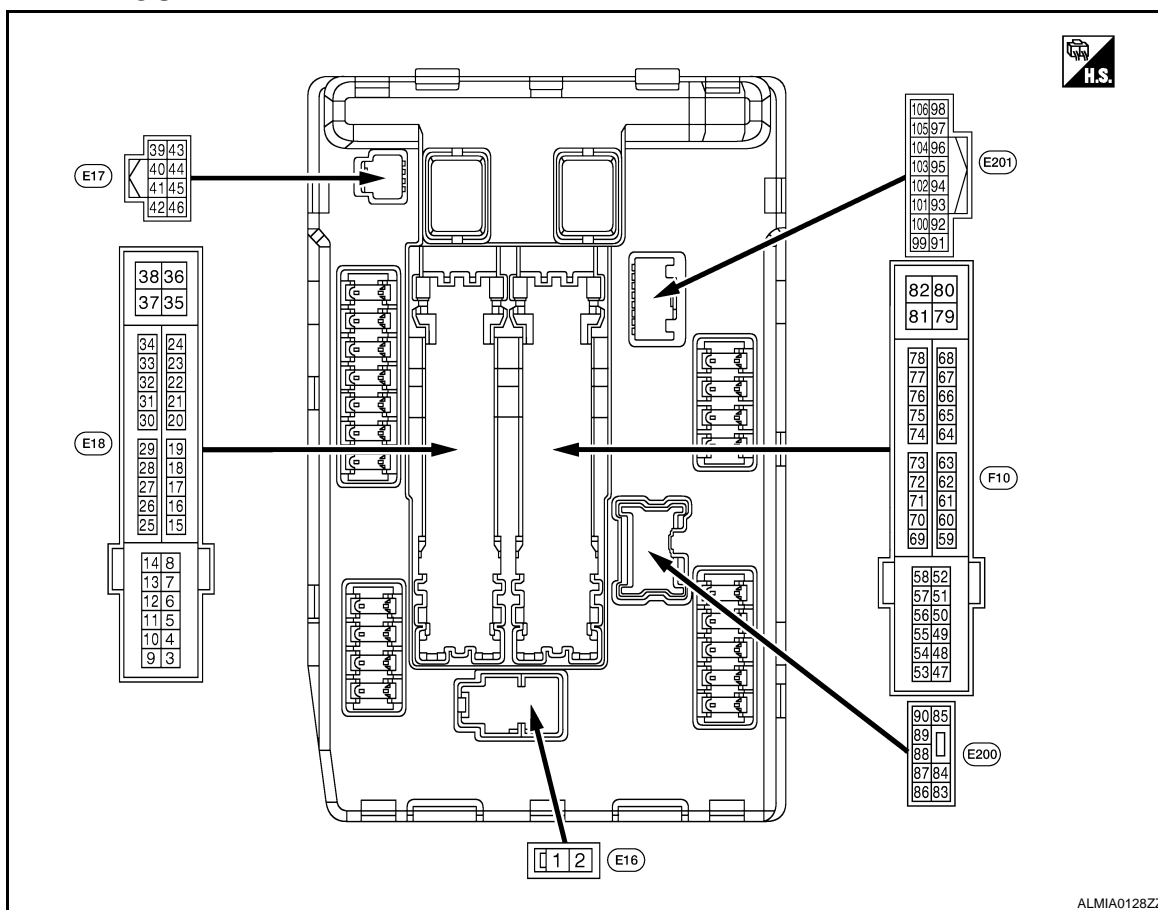

Physical Values

INFOID:000000003301859

PHYSICAL VALUES

IPDM E/R (INTELLIGENT POWER DISTRIBUTION MODULE ENGINE ROOM)

< ECU DIAGNOSIS >

[POWER DISTRIBUTION SYSTEM]

Terminal No. (Wire color)		Description		Condition		Value (Approx.)
+	-	Signal name	Input/ Output			
1 (R)	Ground	Battery power supply	Input	Ignition switch OFF		Battery voltage
2 (B/Y)	Ground	Battery power supply	Input	Ignition switch OFF		Battery voltage
4 (L/R)	Ground	Front wiper LO	Output	Ignition switch ON	Front wiper switch OFF	0V
					Front wiper switch LO	Battery voltage
5 (L/B)	Ground	Front wiper HI	Output	Ignition switch ON	Front wiper switch OFF	0V
						Front wiper switch HI
6 (SB)	Ground	Daytime light relay power supply (Canada models only)	Output	Ignition switch OFF		Battery voltage
7 (R/L)	Ground	Tail, license plate lamps & interior lamps	Output	Ignition switch ON	Lighting switch OFF	0V
						Lighting switch 1ST
10 (R/B)	Ground	ECM relay power supply	Output	Ignition switch OFF (For a few seconds after turning ignition switch OFF)		0V
				<ul style="list-style-type: none"> • Ignition switch ON • Ignition switch OFF (More than a few seconds after turning ignition switch OFF) 		Battery voltage
11 (P/L)	Ground	Steering lock unit power supply	Output	Ignition switch OFF	A few seconds after opening the driver door	Battery voltage
				Ignition switch LOCK	Press the push-button ignition switch	Battery voltage
				Ignition switch ACC or ON		0V
12 (B)	Ground	Ground	—	Ignition switch ON		0V
13 (W)	Ground	Fuel pump power supply	Output	Approximately 1 second or more after turning the ignition switch ON		0V
				<ul style="list-style-type: none"> • Approximately 1 second after turning the ignition switch ON • Engine running 		Battery voltage
15 (BR)	Ground	Ignition relay-1 power supply	Output	Ignition switch OFF		0V
				Ignition switch ON		Battery voltage
16 (L/Y)	Ground	Front wiper auto stop	Input	Ignition switch ON	Front wiper stop position	0V
						Any position other than front wiper stop position
19 (L/Y)	Ground	Ignition relay-1 power supply	Output	Ignition switch OFF		0V
				Ignition switch ON		Battery voltage
20 (B/Y)	Ground	Ambient sensor ground	—	Ignition switch ON		0V
21 (O/B)	Ground	Ambient sensor	—	Ignition switch ON		5V
22 (G)	Ground	Refrigerent pressure sensor ground	—	Ignition switch ON		0V

IPDM E/R (INTELLIGENT POWER DISTRIBUTION MODULE ENGINE ROOM)

< ECU DIAGNOSIS >

[POWER DISTRIBUTION SYSTEM]

Terminal No. (Wire color)		Description		Condition	Value (Approx.)
		Signal name	Input/ Output		
+	-				
23 (R)	Ground	Refrigerent pressure sensor	—	<ul style="list-style-type: none"> Ignition switch ON (READY) Both A/C switch and blower motor switch ON (electric compressor operates) 	1.0 - 4.0V
24 (BR/W)	Ground	Refrigerent pressure sensor power supply	—	Ignition switch ON	5V
25 (G/R)	Ground	Ignition relay-1 power supply	Output	Ignition switch OFF	0V
				Ignition switch ON	Battery voltage
27 (BR/W)	Ground	Ignition relay monitor	Input	Ignition switch OFF or ACC	Battery voltage
				Ignition switch ON	0V
28 (BR)	Ground	Push-button ignition switch	Input	Press the push-button ignition switch	0V
				Release the push-button ignition switch	Battery voltage
31 (G/W)	Ground	Ignition relay power supply	Output	Ignition switch OFF	0V
				Ignition switch ON	Battery voltage
32 (LG)	Ground	Electronic steering column lock unit condition-1	Input	Electronic steering column lock is activated	0V
				Electronic steering column lock is deactivated	Battery voltage
33 (W)	Ground	Electronic steering column lock unit condition-2	Input	Electronic steering column lock is activated	Battery voltage
				Electronic steering column lock is deactivated	0V
39 (P)	—	CAN-L	Input/ Output	—	—
40 (L)	—	CAN-H	Input/ Output	—	—
41 (B)	Ground	Ground	—	Ignition switch ON	0V
42 (SB)	Ground	Cooling fan relay-1 control	Input	Ignition switch OFF or ACC	0V
				Ignition switch ON	0.7V
43 (G/B)	Ground	ECVT device (Detention switch)	Input	Ignition switch ON Press the ECVT selector button (ECVT selector lever P)	Battery voltage
				<ul style="list-style-type: none"> ECVT selector lever in any position other than P Release the ECVT selector button (ECVT selector lever P) 	0V
44 (G/W)	Ground	Horn relay control	Input	The horn is deactivated	Battery voltage
				The horn is activated	0V
45 (L/O)	Ground	Anti theft horn relay control	Input	The horn is deactivated	Battery voltage
				The horn is activated	0V
48 (R)	Ground	Heater pump relay power supply	Output	Engine running	Heater pump OFF
				Heater pump ON (Heater pump is operating)	0V

A
B
C
D
E
F
G
H
I
J
K
L
N
O
P

PCS

IPDM E/R (INTELLIGENT POWER DISTRIBUTION MODULE ENGINE ROOM)

< ECU DIAGNOSIS >

[POWER DISTRIBUTION SYSTEM]

Terminal No. (Wire color)		Description		Condition		Value (Approx.)
+	-	Signal name	Input/ Output			
49 (B/R)	Ground	ECM relay power supply	Output	Ignition switch OFF (For a few seconds after turning ignition switch OFF)		0V
				<ul style="list-style-type: none"> • Ignition switch ON • Ignition switch OFF (More than a few seconds after turning ignition switch OFF) 		Battery voltage
51 (LG)	Ground	Ignition relay power supply	Output	Ignition switch OFF		0V
				Ignition switch ON		Battery voltage
53 (R/W)	Ground	ECM relay power supply	Output	Ignition switch OFF (For a few seconds after turning ignition switch OFF)		0V
				<ul style="list-style-type: none"> • Ignition switch ON • Ignition switch OFF (More than a few seconds after turning ignition switch OFF) 		Battery voltage
54 (G/W)	Ground	Throttle control motor relay power supply	Output	Ignition switch OFF (For a few seconds after turning ignition switch OFF)		0V
				<ul style="list-style-type: none"> • Ignition switch ON • Ignition switch OFF (More than a few seconds after turning ignition switch OFF) 		Battery voltage
55 (W/L)	Ground	ECM power supply	Output	Ignition switch OFF		Battery voltage
56 (R/Y)	Ground	Ignition relay power supply	Output	Ignition switch OFF		0V
				Ignition switch ON		Battery voltage
57 (O)	Ground	Ignition relay power supply	Output	Ignition switch OFF		0V
				Ignition switch ON		Battery voltage
69 (W/B)	Ground	ECM relay control	Output	Ignition switch OFF (For a few seconds after turning ignition switch OFF)		Battery voltage
				<ul style="list-style-type: none"> • Ignition switch ON • Ignition switch OFF (More than a few seconds after turning ignition switch OFF) 		0 - 1.5V
70 (O)	Ground	Throttle control motor relay control	Output	Ignition switch ON → OFF		0 - 1.0V ↓ Battery voltage ↓ 0V
				Ignition switch ON		0 - 1.0V
75 (P/L)	Ground	Oil pressure switch	Input	Ignition switch ON	Engine stopped	0V
					Engine running	Battery voltage
77 (B/R)	Ground	Fuel pump relay control	Output	<ul style="list-style-type: none"> • Approximately 1 second after turning the ignition switch ON • Engine running 		0 - 1.0V
				Approximately 1 second or more after turning the ignition switch ON		Battery voltage
83 (R/Y)	Ground	Headlamp LO (RH)	Output	Ignition switch ON	Lighting switch OFF	0V
					Lighting switch 2ND	Battery voltage

IPDM E/R (INTELLIGENT POWER DISTRIBUTION MODULE ENGINE ROOM)

< ECU DIAGNOSIS >

[POWER DISTRIBUTION SYSTEM]

Terminal No. (Wire color)		Description		Condition		Value (Approx.)	
84 (L)	Ground	Headlamp LO (LH)	Output	Ignition switch ON	Lighting switch OFF	0V	A
					Lighting switch 2ND	Battery voltage	B
86 (W/R)	Ground	Front fog lamp (RH)	Output	Lighting switch 2ND	<ul style="list-style-type: none"> • Front fog lamp switch ON • Daytime light activated (Canada only) 	Battery voltage	C
					Front fog lamp switch OFF	0V	D
87 (L/W)	Ground	Front fog lamp (LH)	Output	Lighting switch 2ND	<ul style="list-style-type: none"> • Front fog lamp switch ON • Daytime light activated (Canada only) 	Battery voltage	E
					Front fog lamp switch OFF	0V	E
88 (R/W)	Ground	Washer pump power supply	Output	Ignition switch ON		Battery voltage	F
89 (L/W)	Ground	Headlamp HI (RH)	Output	Ignition switch ON	<ul style="list-style-type: none"> • Lighting switch HI • Lighting switch PASS 	Battery voltage	F
					Lighting switch OFF	0V	G
90 (G)	Ground	Headlamp HI (LH)	Output	Ignition switch ON	<ul style="list-style-type: none"> • Lighting switch HI • Lighting switch PASS 	Battery voltage	H
					Lighting switch OFF	0V	H
91 (LG/ R)	Ground	Parking lamp (RH)	Output	Ignition switch ON	Lighting switch 1ST	Battery voltage	I
					Lighting switch OFF	0V	I
92 (LG/ B)	Ground	Parking lamp (LH)	Output	Ignition switch ON	Lighting switch 1ST	Battery voltage	J
					Lighting switch OFF	0V	J
97 (V)	Ground	Cooling fan control	Output	Engine idling		0-5V	K
99 (B/Y)	Ground	Ambient sensor ground	—	Ignition switch ON		0V	K
100 (O/B)	Ground	Ambient sensor	—	Ignition switch ON		5V	L
101 (G)	Ground	Refrigerent pressure sensor ground	—	Ignition switch ON		0V	L
102 (R)	Ground	Refrigerent pressure sensor	—	<ul style="list-style-type: none"> • Ignition switch ON (READY) • Both A/C switch and blower motor switch ON (electric compressor operates) 		1.0 - 4.0V	PCS
103 (BR/ W)	Ground	Refrigerent pressure sensor power supply	—	Ignition switch ON		5V	N
105 (V)	Ground	Daytime light relay control (Canada only)	Output	Ignition switch ON	Daytime light system active	Battery voltage	O
				Ignition switch ON	Daytime light system inactive	0V	P

IPDM E/R (INTELLIGENT POWER DISTRIBUTION MODULE ENGINE ROOM)

< ECU DIAGNOSIS >

[POWER DISTRIBUTION SYSTEM]

Wiring Diagram

INFOID:000000003072032

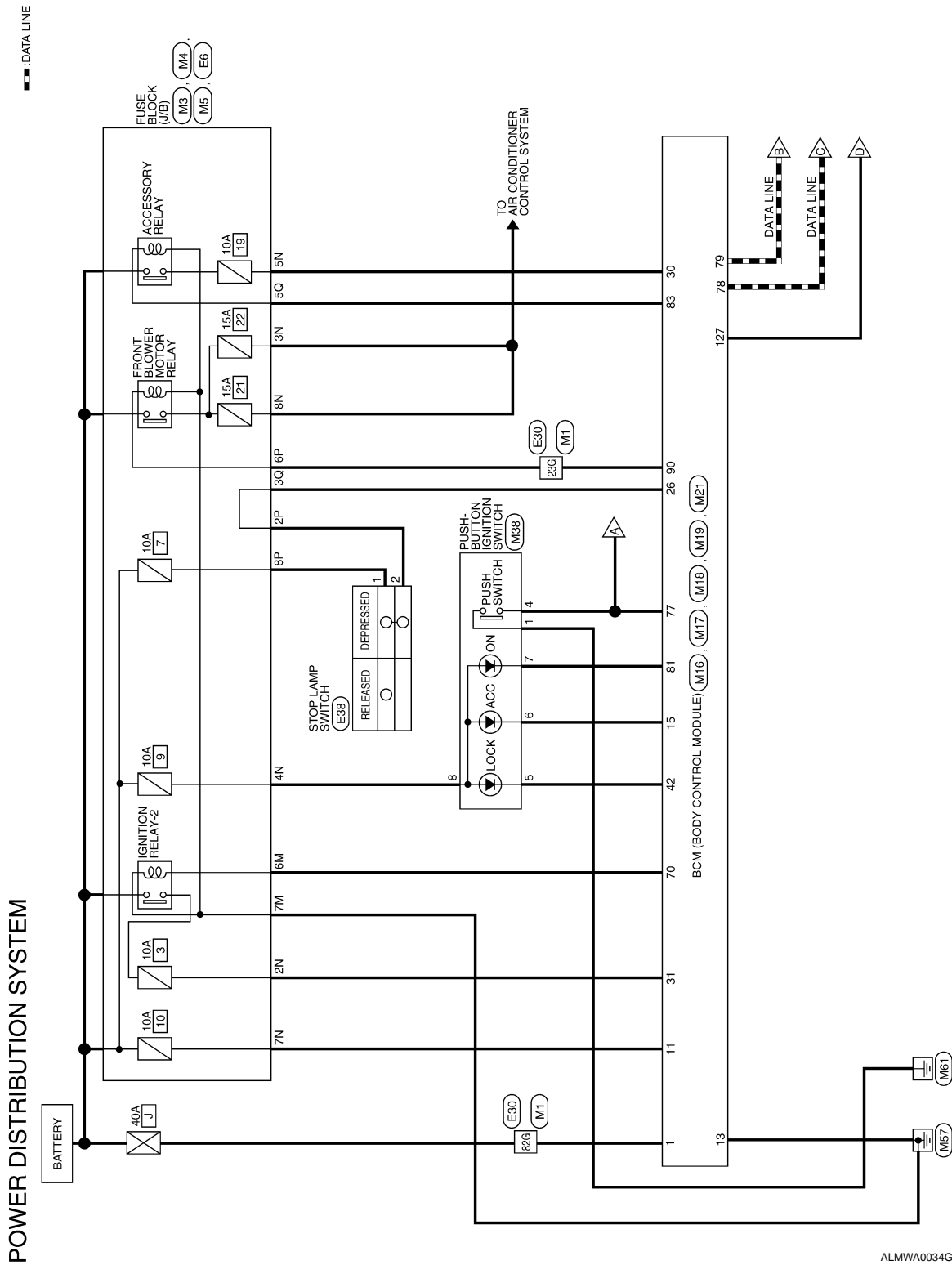

ALMWA0034Gf

IPDM E/R (INTELLIGENT POWER DISTRIBUTION MODULE ENGINE ROOM)
< ECU DIAGNOSIS > [POWER DISTRIBUTION SYSTEM]

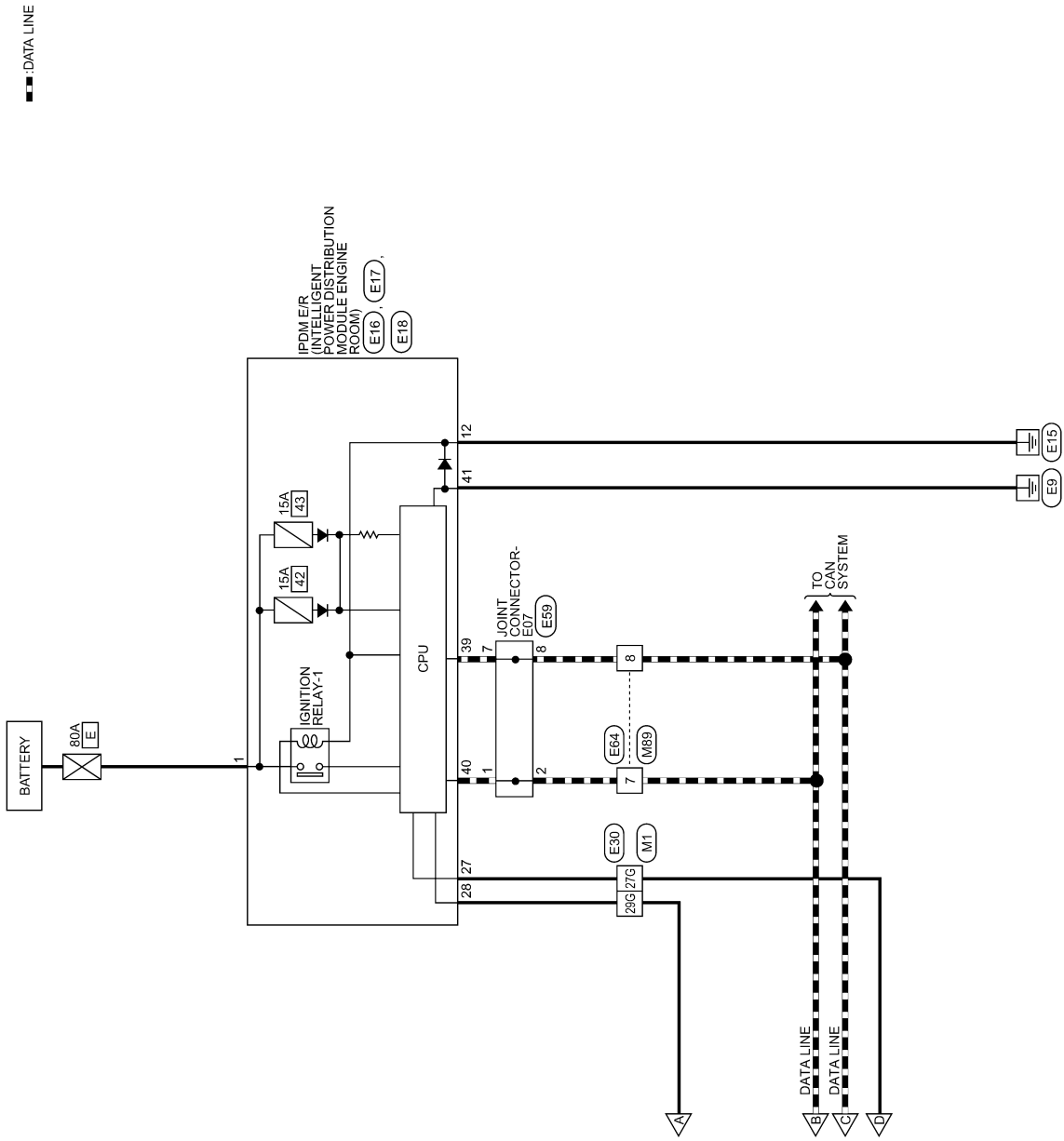

— DATA LINE

A
B
C
D
E
F
G
H
I
J
K
L
PCS
N
O
P

ALMWA0035GE

IPDM E/R (INTELLIGENT POWER DISTRIBUTION MODULE ENGINE ROOM)

< ECU DIAGNOSIS >

[POWER DISTRIBUTION SYSTEM]

POWER DISTRIBUTION SYSTEM CONNECTORS

Connector No.	M1
Connector Name	WIRE TO WIRE
Connector Color	WHITE

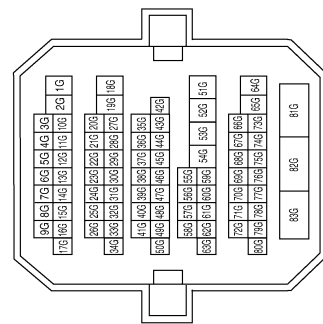

Terminal No.	Color of Wire	Signal Name
23G	Y	-
27G	BR/W	-
29G	BR	-
82G	W/B	-

Connector No.	M3
Connector Name	FUSE BLOCK (J/B)
Connector Color	WHITE

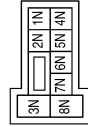

Terminal No.	Color of Wire	Signal Name
2N	G	-
3N	W/L	-
4N	G/Y	-
5N	V/Y	-
7N	Y/R	-
8N	W/L	-

Connector No.	M4
Connector Name	FUSE BLOCK (J/B)
Connector Color	WHITE

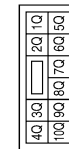

Terminal No.	Color of Wire	Signal Name
3Q	O/L	-
5Q	L	-

Connector No.	M5
Connector Name	FUSE BLOCK (J/B)
Connector Color	WHITE

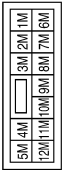

Terminal No.	Color of Wire	Signal Name
6M	R/B	-
7M	B	-

Connector No.	M16
Connector Name	BCM (BODY CONTROL MODULE)
Connector Color	BLACK



Terminal No.	Color of Wire	Signal Name
1	W/B	BAT_POWER_F/L

IPDM E/R (INTELLIGENT POWER DISTRIBUTION MODULE ENGINE ROOM)

< ECU DIAGNOSIS >

[POWER DISTRIBUTION SYSTEM]

Connector No.	M17
Connector Name	BCM (BODY CONTROL MODULE)
Connector Color	WHITE

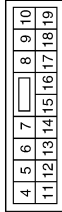

Terminal No.	Color of Wire	Signal Name
11	Y/R	BAT_BCM_FUSE
13	B	GND1
15	Y/L	ACC_LED

Connector No.	M18
Connector Name	BCM (BODY CONTROL MODULE)
Connector Color	GREEN



Terminal No.	Color of Wire	Signal Name
26	O/L	STOP_L_HIGH_SW
30	V/Y	ACC_F/B
31	G	IGN_F/B
42	R	S/L_LOCK_LED

Connector No.	M19
Connector Name	BCM (BODY CONTROL MODULE)
Connector Color	BLACK



Terminal No.	Color of Wire	Signal Name
70	R/B	IGN_ELEC_CONT
77	BR	ENG_START_SW
78	P	CAN_L
79	L	CAN_H
81	LG	IGN_ON_LED
83	L	ACC_CONT
90	Y	IGN2_CONT

Connector No.	M21
Connector Name	BCM (BODY CONTROL MODULE)
Connector Color	GRAY



Terminal No.	Color of Wire	Signal Name
127	BRAW	IGN_USM_CONT1

Connector No.	M38
Connector Name	PUSH-BUTTON IGNITION SWITCH
Connector Color	BROWN

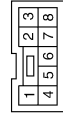

Terminal No.	Color of Wire	Signal Name
1	B	GND
4	BR	START_SW
5	R	LOCK
6	Y/L	ACC
7	LG	ON
8	G/Y	B+

Connector No.	M89
Connector Name	WIRE TO WIRE
Connector Color	WHITE



Terminal No.	Color of Wire	Signal Name
7	L	-
8	P	-

ALMIA0080GB

A
B
C
D
E
F
G
H
I
J
K
L
N
O
P

PCS

IPDM E/R (INTELLIGENT POWER DISTRIBUTION MODULE ENGINE ROOM)

< ECU DIAGNOSIS >

[POWER DISTRIBUTION SYSTEM]

Connector No.	E6
Connector Name	FUSE BLOCK (J/B)
Connector Color	WHITE



Terminal No.	Color of Wire	Signal Name
2P	R/G	-
6P	Y	-
8P	Y/R	-

Connector No.	E16
Connector Name	IPDM E/R (INTELLIGENT POWER DISTRIBUTION MODULE ENGINE ROOM)
Connector Color	BLACK



Terminal No.	Color of Wire	Signal Name
1	R	F/L_MAIN

Connector No.	E17
Connector Name	IPDM E/R (INTELLIGENT POWER DISTRIBUTION MODULE ENGINE ROOM)
Connector Color	WHITE

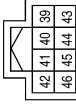

Terminal No.	Color of Wire	Signal Name
39	P	CAN-L
40	L	CAN-H
41	B/Y	S-GND

Connector No.	E18
Connector Name	IPDM E/R (INTELLIGENT POWER DISTRIBUTION MODULE ENGINE ROOM)
Connector Color	WHITE

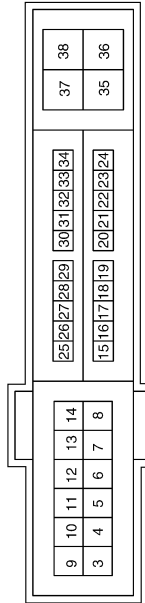

Terminal No.	Color of Wire	Signal Name
12	B	P_GND
27	BR/W	IGN_SIGNAL
28	BR	PUSH_START_SW

Connector No.	E30
Connector Name	WIRE TO WIRE
Connector Color	WHITE

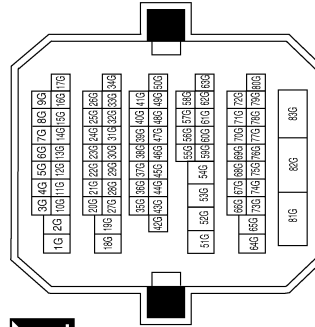

Terminal No.	Color of Wire	Signal Name
23G	Y	-
27G	BR/W	-
29G	BR	-
82G	W/B	-

A
B
C
D
E
F
G
H
I
J
K
L
N
O
P

Connector No.	E64
Connector Name	WIRE TO WIRE
Connector Color	WHITE

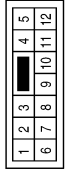

Terminal No.	Color of Wire	Signal Name
7	L	-
8	P	-

Connector No.	E59
Connector Name	JOINT CONNECTOR-E07
Connector Color	BLUE

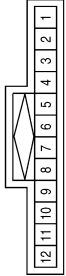
Terminal No.	Color of Wire	Signal Name
1	L	-
2	L	-
7	P	-
8	P	-

Connector No.	E38
Connector Name	STOP LAMP SWITCH
Connector Color	WHITE

Terminal No.	Color of Wire	Signal Name
1	Y/R	-
2	R/G	-

PCS

Fail Safe

ALMIA0082GB

INFOID:000000003301860

CAN COMMUNICATION CONTROL

When CAN communication with ECM and BCM is impossible, IPDM E/R performs fail-safe control. After CAN communication recovers normally, it also returns to normal control.

If No CAN Communication Is Available With ECM

IPDM E/R (INTELLIGENT POWER DISTRIBUTION MODULE ENGINE ROOM)

< ECU DIAGNOSIS >

[POWER DISTRIBUTION SYSTEM]

Control part	Fail-safe in operation
Cooling fan	<ul style="list-style-type: none"> • Signals cooling fans ON when the ignition switch is turned ON • Signals cooling fans OFF when the ignition switch is turned OFF
Heater pump	Heater pump relay OFF

If No CAN Communication Is Available With BCM

Control part	Fail-safe in operation
Headlamp	<ul style="list-style-type: none"> • Turns ON the headlamp low relay when the ignition switch is turned ON • Turns OFF the headlamp low relay when the ignition switch is turned OFF • Headlamp high relay OFF
<ul style="list-style-type: none"> • Parking lamps • License plate lamps • Illuminations • Tail lamps 	<ul style="list-style-type: none"> • Turns ON the tail lamp relay when the ignition switch is turned ON • Turns OFF the tail lamp relay when the ignition switch is turned OFF
Front wiper	<ul style="list-style-type: none"> • The status just before activation of fail-safe control is maintained until the ignition switch is turned OFF while the front wiper is operating at LO or HI speed. • The wiper is operated at LO speed until the ignition switch is turned OFF if the fail-safe control is activated while the front wiper is set in the INT mode and the front wiper motor is operating.
Front fog lamps (if equipped)	Front fog lamp relay OFF
Horn	Horn OFF
Ignition relay	The status just before activation of fail-safe is maintained.
Electronic steering column lock unit	Electronic steering column lock relay OFF

IGNITION RELAY MALFUNCTION DETECTION FUNCTION

- IPDM E/R monitors the voltage at the contact circuit and excitation coil circuit of the ignition relay inside it.
- IPDM E/R judges the ignition relay error if the voltage differs between the contact circuit and the excitation coil circuit.
- If the ignition relay cannot turn OFF due to contact seizure, it activates the tail lamp relay for 10 minutes to alert the user to the ignition relay malfunction when the ignition switch is turned OFF.

DTC	Ignition switch	Ignition relay	Tail lamp relay
—	ON	ON	—
—	OFF	OFF	—
B2098: IGN RELAY ON	OFF	ON	ON (10 minutes)
B2099: IGN RELAY OFF	ON	OFF	—

NOTE:

The tail lamp turns OFF when the ignition switch is turned ON.

FRONT WIPER CONTROL

IPDM E/R detects front wiper stop position by a front wiper auto stop signal.

When a front wiper auto stop signal is in the conditions listed below, IPDM E/R stops power supply to wiper after repeating a front wiper 10 second activation and 20 second stop five times.

Ignition switch	Front wiper switch	Auto stop signal
ON	OFF	Front wiper stop position signal cannot be input 10 seconds.
	ON	The signal does not change for 10 seconds.

NOTE:

This operation status can be confirmed on the IPDM E/R “Data Monitor” that displays “BLOCK” for the item “WIP PROT” while the wiper is stopped.

STARTER MOTOR PROTECTION FUNCTION

IPDM E/R turns OFF the starter control relay to protect the starter motor when the starter control relay remains active for 90 seconds.

IPDM E/R (INTELLIGENT POWER DISTRIBUTION MODULE ENGINE ROOM)

< ECU DIAGNOSIS >

[POWER DISTRIBUTION SYSTEM]

DTC Index

INFOID:000000003301861

A
B
C
D
E
F
G
H
I
J
K
L
N
O
P

CONSULT-III display	Fail-safe	TIME ^{NOTE}		Refer to
No DTC is detected. further testing may be required.	—	—	—	—
U1000: CAN COMM CIRCUIT	×	CRNT	1 – 39	PCS-15
B2098: IGN RELAY ON	×	CRNT	1 – 39	PCS-16
B2099: IGN RELAY OFF	—	CRNT	1 – 39	PCS-17
B2108: STRG LCK RELAY ON	—	CRNT	1 – 39	SEC-85
B2109: STRG LCK RELAY OFF	—	CRNT	1 – 39	SEC-86
B210A: STRG LCK STATE SW	—	CRNT	1 – 39	SEC-87

NOTE:

The details of TIME display are as follows.

- CRNT: The malfunctions that are detected now
- 1 - 39: The number is indicated when it is normal at present and a malfunction was detected in the past. It increases like 0 → 1 → 2 ... 38 → 39 after returning to the normal condition whenever IGN OFF → ON. It is fixed to 39 until the self-diagnosis results are erased if it is over 39. It returns to 0 when a malfunction is detected again in the process.

PCS

SYMPTOM DIAGNOSIS

POWER DISTRIBUTION SYSTEM SYMPTOMS

Symptom Table

INFOID:000000003072035

Before performing the diagnosis in the following table, check the contents of [PCS-35, "Work Flow"](#).

Symptom	Suspect Systems	Refer to
The power supply changing operation is normal. But the push-button ignition switch position indicator does not turn on.	1. Check push-button ignition switch position indicator.	PCS-67
	2. Check Intermittent Incident.	GI-42

ON-VEHICLE MAINTENANCE**PRE-INSPECTION FOR DIAGNOSTIC****Basic Inspection**

INFOID:000000003072036

The engine start function, door lock function, power distribution system and NATS-NVIS in the Intelligent Key system are closely related to each other regarding control. Narrow down the functional area in question by performing basic inspection to identify which function is malfunctioning. The vehicle security function can operate only when the door lock and power distribution system are operating normally. Therefore, it is easy to identify any factor unique to the vehicle security system by performing the vehicle security operation check after basic inspection.

1. CHECK DOOR LOCK OPERATION

1. Check the door lock for normal operation with the Intelligent Key controller and door request switch. Successful door lock operation with the Intelligent Key and request SW indicates that the remote keyless entry receiver and inside key antenna required for engine start are functioning normally. Identify the malfunctioning point by referring to the DLK section if the door cannot be unlocked.

Can the door be locked with the Intelligent Key and door request switch?

- YES >> GO TO 2
NO >> Refer to [DLK-186, "Symptom Table"](#).

2. CHECK ENGINE STARTING

1. Checks that the engine starts when operating the Intelligent Key inserted into the key slot.

Does the engine start?

- YES >> GO TO 3
NO >> Refer to [SEC-178, "Symptom Table"](#).

3. CHECK STEERING LOCKING

1. Does the steering lock when operating door switch after switching the power supply from ON position (or ACC position) to LOCK position?
If door switch is malfunctioning, BCM cannot lock the steering. If BCM does not detect DTC, steering lock unit is normal.

Does steering lock?

- YES >> GO TO 4
NO >> Refer to [DLK-52, "Component Function Check"](#).

4. CHECK POWER SUPPLY INDICATOR SWITCHING

1. Press push-button ignition switch and position indicator will switch from LOCK, ACC to ON gradually when steering is locked. Checks that the position indicator is illuminated at different positions of the circuit.

Is each position indicator illuminating?

- YES >> GO TO 5
NO >> Refer to [PCS-67, "Component Function Check"](#).

5. CHECK VEHICLE SECURITY SYSTEM

1. Check the vehicle security system for normal operation.
The vehicle security function can operate only when the door lock and power distribution functions are operating normally.
Therefore, it is easy to identify any factor unique to the vehicle security by performing the vehicle security operation check after this basic inspection.

>> Refer to [SEC-181, "Vehicle Security Operation Check"](#).

ON-VEHICLE REPAIR

BCM (BODY CONTROL MODULE)

Removal and Installation

INFOID:000000003072037

Refer to [BCS-85](#).